

**MAKE
HISTORY.**

Preserve Manitoba's Past.

Economic History Theme Study

THE DAIRY INDUSTRY IN MANITOBA

1880 – 2000



Karen Nicholson
Historic Resources Branch
March 2002

Acknowledgements:

I would like to thank Allan Neyedly who collected much of the research material for this report during his term position with the Branch in the summer of 2000.

On the cover:

By World War I, the cream separator was becoming more common on farms. The shape of the milk cans changed little over the decades.

Source: *Grain Growers Guide*, January 19, 1916, Cover

TABLE OF CONTENTS

	Page
1. Introduction	1
2. Pre-requisites for Dairy Farming	1
3. Dairy Cattle Breeds	3
4. Regulation of the Dairy Industry	8
A. Federal Dairy Legislation	8
B. Provincial Dairy Legislation	9
C. Milk Control Board	11
5. The Beginnings of the Dairy Industry	12
6. Specialized Dairy Farming	17
A. Dairy Herd Improvement Techniques	17
B. Modernizing Farm Techniques	21
D. Milk Subsidies	21
7. Keeping Milk Products Safe	22
8. Technological Innovations	23
A. Pasteurization	23
B. The Babcock Test	24
C. Homogenization	24
D. Packaging	24
E. Cream Separator	25
F. Refrigeration	30
G. Milking Machines	32
9. Milk Deliveries	32
10. Bulk Milk Collection	39
11. Regions of Dairying	42
A. Central Manitoba	45
B. Interlake	52
C. Parkland	56
D. Southeastern Manitoba	57
E. Westman	60
F. Winnipeg	64
12. Cheese Factories	67
13. Creamery Operations	76

14. Promotion of Dairy Education	89
A. Dairy School	89
B. 4-H Clubs	91
15. Livestock Shows	92
16. Dairy Organizations	93
A. Manitoba Dairy Association	93
B. Manitoba Milk Producers Co-Op Inc	93
C. Manitoba Co-Operative Cheese Producers Association	93
D. Manitoba Buttermakers Association	93
E. Dairy Manufacturers Association	93
F. Dairy Cattle Breeders Association	94
G. National Dairy Council	94
H. Winnipeg District Producers Co-Operative Association Limited	94
I. Manitoba Milk Producers Marketing Board	94
J. Dairy Farmers of Manitoba	95
17. Dairy Structures	95
A. Cowsheds	95
B. Milk House or Dairy Building	105
C. Creamery	109
18. Conclusions	112
19. Inventories	114
A. Milk Plants	116
B. Creameries	121
C. Cheese Plants	137
19. Bibliography	146
20. Endnotes	153

LIST OF ILLUSTRATIONS

		Page
1.	The Dairy Maid, 1916	cover
2.	Farmwoman churning butter, 1916	2
3.	Guernsey cow	6
4.	Advertisements for dairy cattle, 1919	7
5.	Ukrainian settlers delivering cream to railway	14
6.	Children carrying bottled milk home	15
7.	Cattle grazing	16
8.	Promotional material for dairy industry, c1915	20
9.	Advertisements for cream separators, 1917-1918	26
10.	Advertisement for cream separator, 1918	27
11.	Advertisement for De Laval dairy company, 1919	29
12.	Diagram for cooling tank, 1916	31
13.	Advertisement for milking machine, 1919	33
14.	Interior of 1919 barn	34
15.	Cows being milked by milking machine, 1919	34
16.	Advertisement for cream separator, 1915	36
17.	Avondale Dairy truck, 1940	40
18.	Bulk milk truck, 1989	40
19.	Map showing regions of dairying, 1960	44
20.	Advertisement for a cream separator, 1916	46
21.	Dairy barn, c1930s	48
22.	Leslie Dairy Farm, La Salle, c1960	51
23.	Lady milking a cow	53
24.	Unloading cream cans	58
25.	Glencarnock Stock Farm, Brandon	62
26.	Cummings, Dairy Farm, Winnipeg	65
27.	Early milk delivery wagons in Winnipeg	66
28.	Plan for a cheese factory	69
29.	Interior plan for a cheese factory	70
30.	Arnaud Cheese Factory opened in 1937, as it looked in 1972	72
31.	Kraft-Phenix Cheese plant in La Broquerie, opened in 1935	74
32.	Salt advertisement, 1919	77
33.	Advertisement for butter wraps, 1919	79
34.	Fisher Branch Creamery, 1936	80
35.	Advertisement for home butter churn	82
36.	Advertisements for cream shippers and a butter churn	83
37.	Inside Fisher Branch Creamery	85
38.	Inside Fisher Branch Creamery	86
39.	Manitoba Co-operative Creamery	88
40.	A cream shipping station along the railway	90
41.	A 4-H Dairy Club member	92
42.	Plan for a standard dairy barn, 1915	97
43.	Interior of 1915 barn	98
44.	Interior of 1915 barn	99
45.	Types of accommodations for dairy cattle in barns	101
46.	Ninette barn, 1901	102

47.	Milking parlour spatial arrangements	104
48.	Milk houses in Interlake region.....	106
49.	Plan for a milk house.....	107
50.	Plan for a structure to hold milk cans	108
51.	Plan for a creamery, 1900.....	110
52.	Interior of Fisher Branch Creamery	111
53.	A modern dairy operation	115

INTRODUCTION

"A dairy farm is defined by the census as having 51% or more of its total sales of farm products from dairy products, or from 40 to 50.9 % of total sales from dairy products provided that with the addition of cattle and calves sales make up at least 51% of total."¹ There are, in 2001, 639 producers of raw milk in Manitoba, and while many of these combine dairy farming with cereal grain farming, dairying is an important source of agricultural income in Manitoba.²

Today, Manitoba ranks fifth in Canadian provinces in the production of milk and the processing of milk products, but the dairy industry started slowly in this province. During the pioneer period, all farm families kept at least one cow for their own needs. The creation of trading centres and transportation facilities meant that farmers could sell the excess cream, which they had separated from the milk, or the homemade butter they had produced from it. The first processing plants were cheese factories, located within a ten-mile radius of milk producers. The creation of railways meant that processing plants could be located at a greater distance from the producers. From 1890 -1950, the dairy industry revolved around shipping cream cans on the train to processing plants located within a fifty-mile radius, and the selling of bulk milk by dairies located close to major urban centres. After 1950, mechanization of the industry created large dairy herds dedicated to the production of fluid milk. Tanker trucks carried this fluid milk directly to large processing plants. The number of milk producers decreased while the number of dairy cattle grew. The average dairy farm today has 40 cows, almost double the number of 25 years ago, and the average cow gives almost twice as much milk, due to better feeding, disease control and genetic advances.³ Similarly, the number of milk-processing plants has decreased while the combined capacity has increased. This rationalization of the industry continues today as a direct result of globalization.

PRE-REQUISITES FOR DAIRY FARMING

During the historical period, the pre-conditions for successful dairy farming consisted of the following factors: adequate pastureland, an urban market, a good milk-producing herd, transportation facilities, a processing plant within a reasonable distance, and a knowledge of dairy methods.

Much of southern Manitoba consists of chernozemic (black and gray) soil, which is ideal for wheat production. Portions of the eastern margins of the Red River Valley and the Interlake, although they contain chernozemic soil, are also affected by gravel deposits and poor drainage, associated with the receding beaches of Glacial Lake Agassiz. The former beach ridges render the black soil unsuitable for grain production, while the many water holes make it ideal pastureland. These areas also satisfy another condition for dairy production: proximity to a market. Milk is a very perishable product and therefore in the historic period its producers had to be within an hour's travel of a market or processing centre. Most of the dairy farms around Winnipeg fall within Winnipeg's milk shed (area in which dairy operations are set up to serve the needs of the city).



This farm lady is using a more common kind of butter churn, which worked by moving the plunger up and down. Beside the churn are the bowl and wooden paddle used to beat the water out of the butter after the cream had solidified.
Source: *Grain Growers Guide*, 9 February, 1916, p.10

Other regions of the province where dairy production was sizable included the Brandon and Dauphin areas, where the milk could be sold to the nearby urban population. Two areas in the province, not close to urban centres, but where dairy farms were created, were the Pembina Hills and the Whitemouth Valley. Both these regions had the soils and water conditions for good pastures, but not for grain production. They lacked proximity to a nearby market, but the development of railways made this less of a problem. Dairy farming in these regions was more determined by another factor: knowledge of dairy farming. New immigrants brought this from their former homes.

A dairy farmer could sell his milk to local customers in a nearby community, or he could send it to a cheese factory for processing. His cream, which was less fragile than milk, could be shipped to a creamery. Between 1880 and 1900, approximately 75 cheese factories and 30 creameries were opened in local communities. Before their existence, however, the farmer used his excess skimmed milk to feed his hogs and other livestock while his wife sold her homemade butter to the local storekeeper, who then resold it to town dwellers. As branch railways were created across Manitoba, a daily or bi-weekly delivery service to nearby processing plants was developed. In these early years, a lack of cooling or refrigeration facilities limited the distance milk or cream could be shipped without spoilage.

Dairy farming differed from livestock raising. Most settlers had cattle, and although they might milk them and sell the cream, these were not necessarily dairy cattle. In 1900, most cattle in Manitoba were shorthorns; a breed raised more for beef than milk. Many settlers, especially the French and Belgians, emigrated from territories where dairy farming was prevalent. They therefore brought with them knowledge of dairy cattle. Many of these immigrants settled around Winnipeg and in southeastern Manitoba, areas where a large dairy industry became rooted. They also settled in the Pembina Hills region, and because of their historic connection to dairying, they used the hilly land for pasture for dairy herds, even though they lacked the proximity to an urban market. Once fluid milk collection became a standard, the distance from market was no longer a limiting factor in that region.

Because the Department of Agriculture recognized that the specialized knowledge required to maintain a dairy herd may have been lacking on many of the early dairy farms, the department took steps to remedy this by offering courses and sending special dairy trains traveling across the province. The government also passed special legislation regarding the marketing of dairy products.

DAIRY CATTLE BREEDS

Dairy breeds, ranked according to their milk production, are Holstein, Brown Swiss, Ayrshire, Guernsey, and Jersey. Rated according to the basis of butterfat in their milk, they line up thusly: Jersey, Guernsey, Ayrshire, Brown Swiss, and Holstein.⁴

The first cattle in Red River arrived with the first Selkirk settlers in 1811. Feed and watering logistics for the long sea voyage forced the settlers to leave Scotland without cattle. Miles Macdonell acquired a cow and a bull, named Adam and Eve, at Oxford House. These, combined with three North West Company cattle, gave the colony a cattle population of five, but once Adam died, no bull for breeding. Lord Selkirk captured a bull and three cows at the North West Company post at Rainy Lake on his way to Red River in 1817. These cattle were later returned to the North West Company traders at Fort Gibraltar, who, to the horror of the Scottish settlers, slaughtered them. Lord Selkirk's many attempts to ship cattle from England, or have them driven overland from St. Louis, all ended in failure. In 1821, after Selkirk's death, Joseph

Rollette managed to bring a small herd safely through Dakota country to Red River. A major expedition, and one authorized during Selkirk's lifetime, came to a more fruitful conclusion in 1822 when Andrew Stewart brought a herd of 170 cattle from St. Louis. Many of these were sold to eager settlers before Hudson's Bay Company Governor, Andrew Bulger, could work out the best method of distributing them. Officially he gave a receipt for 96 milk cows, one bull, and 23 oxen. Bulger's method of distribution did not please everyone in the colony.⁵

He reported:

I began with the married men of the De Meurons, to whom Lord Selkirk made promises in writing; next I considered the Scottish families which had been the longest in and suffered the most for the country; then the married Canadians from Montreal. These being served I was induced, in the hope of reconciling [the Swiss] to the country to give a cow to each of them that had a family. I supplied the three German families and then the married men of all countries who appeared to have the strongest claims on Lord Selkirk. No one was allowed to choose; I adopted a kind of lottery...⁶

In 1823 Andrew Stewart arrived with another drive of 210 head of cattle and thereafter the cattle needs of the colony were satisfied. The breeds of these cattle were not mentioned. Alex Macdonell stated that he purchased two white cows and one black one.⁷ The cattle population at Red River grew to 1200 in 1831 and 6500 by 1851, bringing with it a decline in the price of dairy products due to over-production.⁸ There was no recognized dairy breed in Manitoba, and no evidence of breeding for production. Although there were 19,000 cows in Manitoba in 1880, any farmer in the dairy business was truly a pioneer.⁹ By 1885, there were 100,000 cattle in the province, mostly of Shorthorn type.¹⁰ This seems to indicate that most of the original herds brought from the United States were of that variety.

Shorthorns, also known as Durham, after the area in England where they were first developed, vary in colour from a solid red with white markings, to all white or roan. They are medium milk producers, but good beef cattle. Because of their ability to withstand Manitoba's harsh winters, they served the purpose of the pioneer era very well, allowing a farmer to milk a cow for his family's needs and to process excess cattle into beef.

Another all-purpose breed used in Manitoba's early years was the Red Poll. Originally from the counties of Norfolk and Suffolk in England, this breed is red in colour and polled (meaning its horns have been removed). Although not a recognized dairy breed, they have a capability of producing 7000-8000 pounds of milk annually.¹¹ Since they were prevalent in the Mississippi Valley, it is likely that some of this variety were included in the first herds brought to Red River. H.V. Glendenning brought the first registered herd of Red Polls from Wisconsin to Harding, Manitoba in 1904.¹² He and W.J. McComb of Beresford were the two most important pioneer breeders of Red Poll cattle in Manitoba.

For the purpose of improving the quality of the settlement's cattle, the Hudson's Bay Company brought three specimens of the Ayrshire breed to the Red River Settlement in 1848. Two Ayrshire cows and an Ayrshire bull were selected in their native Scotland by Captain Pelly and conveyed to York Factory, and on to Red River, by York Boat. Light to deep cherry, mahogany, brown or a combination of these colours, with white markings, the breed is noted for its grazing abilities. This type of cattle can be maintained on inferior pasturage. In 1879, G. Grummet of Nelson (Morden area) acquired two purebred cows from Ontario. Interest in the breed grew.

Enough breeders existed in Manitoba by 1927 to form the Ayrshire Club. George Steach of Brandon was responsible for revitalizing interest in this breed in Manitoba in 1953.¹³

Holstein-Friesian cattle were developed in the Netherlands and northern Germany and first made their appearance in Manitoba in 1881 when Archibald Wright brought them from St. Paul to his farm along the Assiniboine River. The distinctive black and white Holstein is a large animal, weighing up to 2200 pounds. Noted for its milk production, it quickly became a very prominent species on dairy farms across Manitoba, being successfully exhibited at the Winnipeg Industrial Exhibition of 1903. By 1927, when a Manitoba Holstein Association was formed, Sam Sims of Stonewall, who has been described as "the father of Holsteins in Manitoba", estimated that there were 95-100 breeders of Holsteins in the province.¹⁴ Important promoters of the breed were the Manitoba Government Institutional farms at Selkirk, Brandon, Portage la Prairie and Headingley, where the Holsteins supplied the institutions with milk as well as therapy for the inmates. Farmers who kept a few dairy cattle to milk for their cream rarely included Holsteins in their herds. During the Depression, when cream shipping became a major source of agricultural income, the low butterfat content of their milk made Holsteins an unpopular breed.

The Jersey originated on the Isle of Jersey. Its soft fawn colouring makes it easy to distinguish in a farmer's field. The first public display of Jersey cattle in Western Canada was at the Winnipeg Industrial Exhibition in 1903. Four Manitoba breeders, W.N. Edwards of Souris, D. Smith of Gladstone, F.J. Dash of Hillesden, and S.P. Hodgson of Headingley had begun pioneering the breed in the late 1880s. Henry Thomas' herd at Hartney spawned successful herds for Ed Fotheringham of Brandon and Alex Arthur at Edwin, as well as for numerous other breeders who formed the Jersey Cattle Club in 1927. The market for butterfat-rich Jersey milk has been a factor in the popularity of this breed. When the medical profession concluded that high butterfat content contributed to heart disease, the demand for whole Jersey milk declined, as did the number of breeders. In recent years, with the promotion of Jersey cream, the breed has made a comeback.

The Guernsey, the second highest producer of butterfat-rich milk, was a latecomer to the Manitoba dairy scene, not arriving until 1923, when George Cornwall of Dauphin imported three carloads of the breed from Wisconsin. From the Channel Islands off the coast of Normandy, this breed is also fawn-coloured but with more noticeable white markings. It produces a distinctively yellow-coloured milk. Laws dating back to 1819 forbade the importation of live cattle to the Islands, thus keeping the breed pure. The Canadian Government first imported Guernseys to Canada in 1878 and the breed became very popular in Ontario. The cattle are medium-sized and quiet in temperament. Dauphin dairies, owned by George Cornwall and Jack McKillop, both produced Guernsey milk and cream for sale to Dauphin residents. Cornwall was also the founder of the Manitoba Guernsey Club in the early 1920s.¹⁵ Gartmore Farms carries on the Guernsey tradition in the Dauphin area.

The Brown Swiss, a breed that originated in Switzerland, is solid brown, in varying shades. *Calm and unexcitable, they are dual-purpose cattle as well. The Brown Swiss was introduced to the southwestern part of Manitoba from North Dakota. The earliest prominent breeder was Dr. Louis Delaquis, of Notre Dame de Lourdes, who first purchased his herd in 1946. The Manitoba Brown Swiss Association was formed in 1961.*¹⁶

Given the choice of so many breeds, many factors, such as availability and previous ownership, played a role in how dairymen made their choice of cattle. At first, the herds were not purebred. As the industry became more developed, and government programs offered assistance, most dairy farmers made a choice to go with one breed exclusively. This focus allowed them to earn

money, not only from the sale of the milk products, but also from the sale of new calves to other dairymen wishing to upgrade the quality of their herds. In 1975, large dairy herds, consisting of 50-200 cattle each, were made up of Guernsey, Jersey, or Holstein cattle. Most herds of fewer than fifty cattle consisted of Brown Swiss or Ayrshire cattle. This would seem to indicate that there were many farmers who, while producing dairy products for sale, were engaged in a mixed-farming economy. Or it could have been an indication of the large number of French-speaking dairymen, who preferred the Brown Swiss variety.

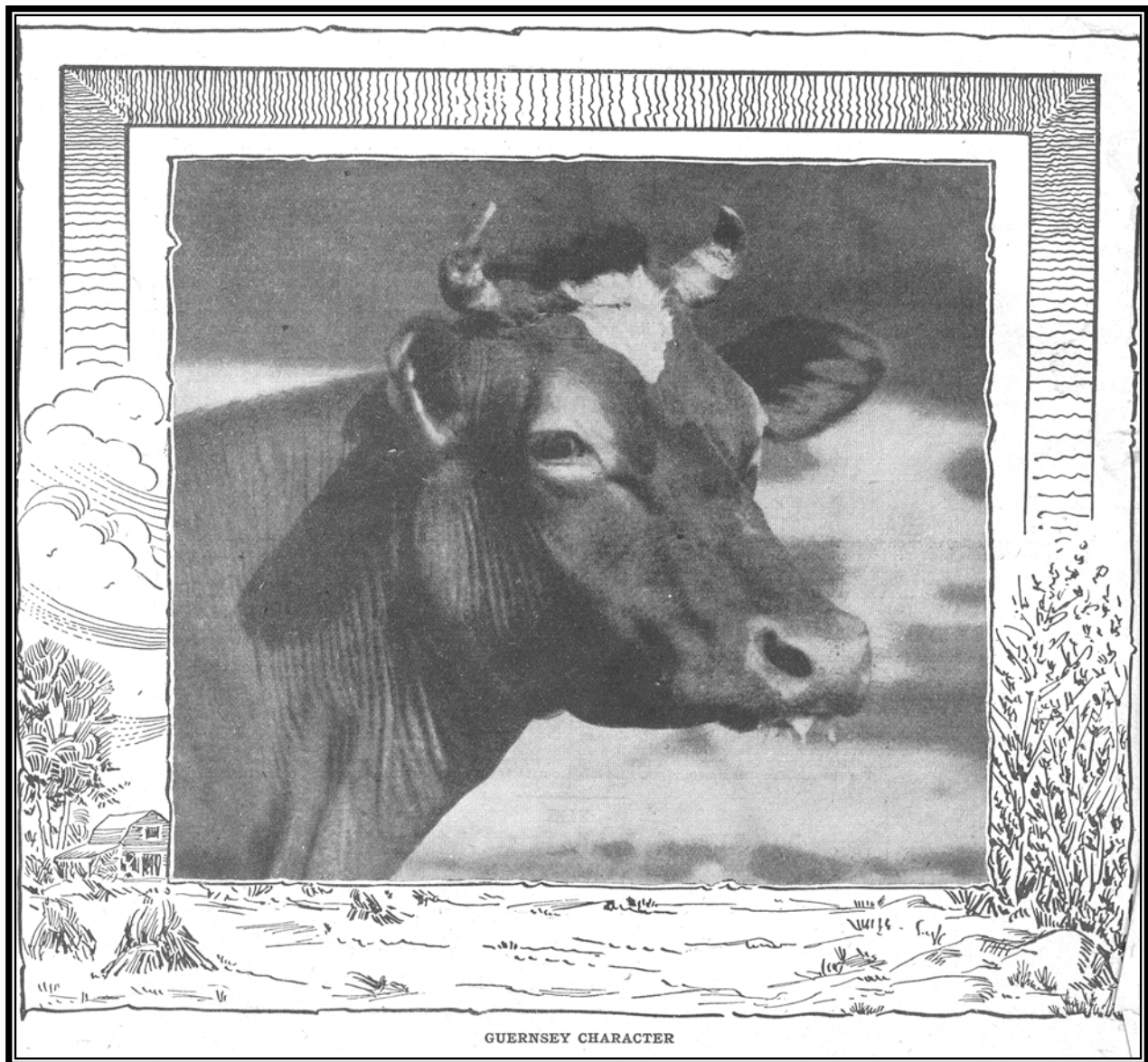

The Guernsey was first introduced to the Manitoba dairy scene in 1923 by George Cornwall of Dauphin. Source: *Nor'-West Farmer*, 5 November 1918, Cover

DELORAINE DAIRY STOCK FARM

Here we are again! Back from the big Fairs with the Long Improved English Berkshires. We have some of the best stock in young boars and sows for breeding purposes we have ever raised from our present stock hog, "High Bluff Laddie" (32012), which won first and reserve champion at Brandon, Regina and Saskatoon, and won high honors in all other classes. Can supply pairs not akln.. Holstein (pure-bred) bulls, helpers and cows for sale; also nice grades.. Apply
CHAS. W. WEAVER, DELORAINE, MAN.

More Milk - Better Milk

Thorough tests on the Government Experimental Farms show that cows after being dehorned give more and better milk. The **Keystone Dehorner** is the most humane and efficient instrument for the purpose. Write for booklet.
R. H. McKENNA, 219 Robert St., Toronto.

Advertisements like these appeared in all the agricultural magazines.

Source: *Grain Growers Guide*, 9 February, 1919, p. 38; *Farmers Advocate & Home Journal*, 2 April, 1919, p. 573

Holsteins

HOLSTEINS

A few choice bull calves from one to two months old. Sired by the imported Long Beach Korndyke Beets, the bull with the butterfat backing. Out of heavy producing daughter of Jessie Fobes Tritomia Duke, sire of 23 A.R.O. daughters. They are priced to sell. Write for full particulars.

Jno. Oughton & Son : Stonewall, Man.

ALTANA HOLSTEINS

We select and breed for capacity, high production and persistency. We own the champion cow of the British Empire for two successive yearly tests. For young bulls bred right get in touch with us.

John Russell :: Alix, Alta.

HILLSLEY HOLSTEINS

Look at the records behind our herd bull—De Kol King of the Netherlands 27547. Official yearly records all made in Saskatchewan:
 Dam at 2 years—10,796 lbs. milk, 446 lbs. butter.
 Dam's dam.....—12,276 lbs. milk, 566 lbs. butter.
 Sire's dam.....—12,362 lbs. milk, 567 lbs. butter.

Several of his young sons out of granddaughters of Dutchland Colantha Sir Abbekirke 17140, 31 tested daughters, for sale.

JENSEN BROS. Hillsley via Humboldt, Sask.

REGULATION OF THE DAIRY INDUSTRY

Dairy foods are an essential part of every person's diet. Because they have a limited shelf life, and because there is a high risk of disease being transmitted through dairy products, the dairy industry is one of the most controlled economic endeavours in Canada. There are two levels of legislation, one under the federal Department of Agriculture, which was created in 1868, and the second under the Manitoba Department of Agriculture, which was established in 1870. While the federal legislation mostly concerns protection for the consumers of dairy products, the Manitoba legislation covers nearly every step of production, processing and marketing of dairy foods.

FEDERAL DAIRY LEGISLATION

The federal Dairy Branch was established in 1890, and in 1893, the Dairy Products Act was passed, aimed at setting a Canada-wide standard of manufacture, inspection, grading, marking and packaging for sale of dairy products. This act has been widened and revamped many times over the years. In 1914, the Dairy Industry Act defined dairy products to include milk, cream, condensed milk, milk powder, butter, cheese, and articles manufactured from milk, as well as imitations of milk. Because the largest portion of dairy producers live in Eastern Canada, federal policy has always been dominated by the needs of Ontario and Quebec's dairy producers.

Federal legislation also was aimed at creating strong healthy breeds in Canada. In 1879, the Federal Animal Contagious Diseases Act was passed to prevent the spread of disease among all species of livestock. In 1912, purebred livestock associations were affiliated under the Canadian National Livestock Records. The most important legislation for improving breeds was the Canadian Record of Performance (ROP). This provided for the keeping of records lactation testing over a period of 365 days for all purebred dairy cattle. The interval was later lowered to 305 days. Administered by the Federal Livestock Division, the program provides production records for each cow tested and this information provides the basis for effective breeding programs. The value of the program is supported by the statistics for a sample year, 1965-66, when milk production certificates for a one-year period were issued for 112,555 cows.¹⁷

Another breed up-grading strategy was the sire loan policy. From 1913-1962, under this program the federal government purchased approved bulls and loaned them to farmers' associations in each province. In order to encourage the development of a uniform type of animal in a district and to promote a community system of breeding, each organization was limited to one breed. Another program, instituted during World War II, was aimed at increasing milk production by helping farmers improve feeds and fodder. The policy provided subsidies for feed freight and storage, fertilizers, and production of coarse grains for feed. Since its inception in 1941 this feed-freight assistance program has been altered many times and has generally benefited eastern dairy producers, especially those in the Maritimes where feed is in a more limited supply.

The federal government's first large-scale program to support farm prices by subsidization was inaugurated during the Depression. Struck down by the Supreme Court in 1936, the Natural Products Marketing Act proved to be the first of many subsidization programs used to stabilize prices for farm produce. During World War II, the Wartime Prices and Trade Board used subsidies to stimulate production of certain products such as cheese and butter, while at the same time making certain that prices did not rise unduly. To prevent a farm price collapse, similar to that which followed World War I, in 1946 the Agricultural Prices Support Board (later

known as Agricultural Stabilization Board) was created. This Board, armed with various statutes, was given the responsibility to guarantee the prices of dairy products, to arrange bulk purchase agreements with foreign governments and to arrange for storage and processing of agricultural products.

Over the years the Board has used various methods to support dairy production. One method was the "offer-to-purchase" plan, whereby the Board sold butter and cheese at cost plus storage charges. Another method was direct subsidies to producers of manufacturing milk. In 1966 the Canadian Dairy Commission (CDC) was established, with the mandate to stabilize the price of manufacturing milk and cream, to guarantee producers a fair return, and to ensure consumers an adequate supply of dairy products. The Commission was also given authority over inter-provincial and export trade.

Under the CDC, the Canadian dairy sector has been under supply management for the past thirty years. The CDC chairs the Canadian Milk Supply Management Committee, which oversees the domestic milk supply. In 1970 the CDC established an aggregate national quota for industrial milk production as well. It was signed by all the provinces by 1974. Under the plan, national quota is allocated to provinces according to historical market shares (Market Share Quota, or MSQ).¹⁸ Provincial quota allocation may be increased or decreased according to domestic needs nationally and could be potentially moved inter-provincially, based upon utilization of the quota. Changes in population could be a factor in this.¹⁹ Under pooling agreements, revenues are shared among the dairy producers of all nine signatories (provinces) of the Plan.

The provincial quota is distributed among producers according to provincial legislation or regulations. In Manitoba there are four ways to acquire or increase milk production quotas for individual farmers. Quotas may be transferred within the family, or transferred or sold with the farm. A monthly quota exchange is administered by the Milk Marketing Board, which also has the power to issue additional quotas. If for any reason a farmer cannot meet his quota, he can bank up to 30-days worth of quota credits.

The Canadian Dairy Commission also administers price support and subsidy programs for Canadian dairy farmers.

PROVINCIAL DAIRY LEGISLATION

While the federal government laid down most of the legislation concerning the sale of dairy products, it was the provincial Department of Agriculture which took responsibility for protecting the quality of the products. *The Manitoba Dairy Act* was brought into force in 1885. It provided the basis for the creation of creameries and cheese factories. In 1893, legislation exempted taxation on all land, buildings and machinery used in connection with creameries and cheese factories. This was passed as an inducement to the establishment of these industries in rural Manitoba and was repealed in 1920. *The Butter and Cheese Brand Act* of 1901 required that brands for creamery butter be registered, and properly labelled. *The Milk and Cream Act* of the same year set the minimum butterfat requirements for milk and cream. It also gave the Superintendent of Dairying the authority to prosecute violations of the Act.

Professor Ellis, in his history of the Manitoba Department of Agriculture, points out that this early legislation to regulate the dairy industry stemmed from pressure from dairymen who had immigrated to Manitoba from Eastern Canada where such controls over quality had existed. *The Dairy Act* required annual testing for butter makers, cheese makers, and milk and cream

testers. This presented the Department of Agriculture with a whole new set of responsibilities: providing educational courses to train people properly to work in the dairy-processing industry. The Dairy Branch of the Department was very successful in raising the quality of dairy production. For example, in 1942-43, the quality of Manitoba cheese was 93.12% first grade and federal inspectors graded 98.3% of Manitoba produced butter as "Canada First Grade".²⁰ Manitoba dairy exhibits were awarded 65% of all first prizes at the Canadian National Exhibition in 1951-52.²¹

The Dairy Act of 1915 stated that building and premises of dairy-processing plants (creameries and cheese factories) should be kept in a sanitary condition, satisfactory to any dairy inspector appointed under the provisions of the Act, and that manufacturing conditions should be sanitary. By 1935, it was obvious that, in spite of the Dairy Branch's efforts, conditions in many plants were less than ideal. This was due in part to a lack of capital. When the Dairy Board was established in 1935, part of its responsibilities was to investigate and approve all applications for new dairy plants in the province. The Dairy Board had to certify that a new plant was necessary and that a supply of milk and cream existed in the district to make the operation viable. Most small towns were anxious to have a creamery established but many of those opened during the Depression had been established "on a shoestring,"²² and consequently the standards of sanitation had suffered considerably. With the new legislation, a new plant could only be established with a special permit from the Minister of Agriculture and this was only issued once the Dairy Board had certified that a new plant was necessary.

Once the dairy producers began switching to bulk milk tanks, regulations were put in force in 1957 to regulate the standards of this process. A training service was instituted for the tank truck drivers to qualify them for a Tank Milk Graders License.

In Canada, but especially in eastern provinces, the lobby against the marketing of butter substitutes was very strong. The problem was not resolved until 1949 when the Supreme Court finally ruled that margarine could be sold. Following the Supreme Court's ruling that margarine was legal, the Manitoba Legislature passed *The Margarine Act*, which prohibited the colouring of margarine to make it resemble butter. Many attempts were made by the manufacturing industry to have this repealed. In 1956 margarine colouring restrictions were removed, although the product was subject to the same moisture restrictions as butter. In Manitoba, the opposition to margarine stemmed from the fact that of the products (i.e. fish oils, soy bean, and cottonseed) used to create margarine, none were produced in Manitoba. It was not a case then, of one set of Manitoba agriculturists competing against another group. The same lobby was at work across Canada. To this day, margarine sold in Quebec may not be coloured to resemble butter.

In 1971, a comprehensive consolidation of dairy control services was undertaken under the Department of Agriculture which had the power

to administer the regulations under the Dairy Act, Public Health Act, Milk and Dairy Product Control Act, Natural Products Marketing Act, and the Margarine Act, in matters pertaining to production, transportation, processing, public health (safety) and composition of milk and milk products, and certain products of vegetable oil origin, produced, processed and sold in Manitoba.²³

Assistance is given to dairy producers to meet quality requirements, increase efficiency of production, and market effectively through centrally controlled programs.

MILK CONTROL BOARD

Manitoba was the first province in Canada, and the first area in North America, to inaugurate milk control legislation. Because of a discrepancy in milk prices caused by the introduction in Manitoba of chain stores, with their own dairy-processing plants, in the early 1930s, the Manitoba Government declared milk a Public Utility. Milk delivery was placed under the Municipal and Public Utility Board, and *The Utility Board Act* was amended in 1932 to include:

to make any plant, premises, equipment, service or organization for the production, handling, bottling, furnishing, delivery, keeping for sale or resale of milk, including products thereof in liquid form, a public utility.

The board had the right to intervene in the public interest should the production and distribution of milk be interrupted.

In 1937, *The Milk Control Act* was passed to provide milk marketing with a separate board. The Manitoba Milk Producers Marketing Board (MMPMB) and the Milk Control Board of Manitoba (MCBM) each have their respective mandates. MMPMB is in charge of the actual physical movement of milk and the operator component of the industry. In effect they regulate producer and processor volumes and quality of product. They also determine the destination of the product. The MCBM is in charge of the price received by the producer, as well as the price charged by the processors, marketers and consumers. The board consists of elected producers whose objective is to allow farmers to jointly take action to protect and improve their incomes through the control, regulation and promotion of the marketing of their product. It establishes the price for all milk classes except fluid milk. Part of the 1971 reorganization of dairy legislation included the revamping of this Act to enlarge the membership of the Milk Board and to give the Board jurisdiction over the milk transportation system which physically moves milk from the farms to the processing plant.

The main objectives of Manitoba's milk control policy is to insure a continual supply of good quality milk, which, while meeting strict standards, will provide the consumers with a reasonably priced product and also allow the producer and distributor to cover their costs. Consequently the Board has the right to set the minimum price to be paid producers and maximum price to be charged consumers.

The government system of control restricts the quantity of milk that can be produced and the price that can be received for the product. Both these factors determine a farmer's gross return. He is also restricted by penalty for over supply on total product and for fluctuations in supply through time. But the seasonal fluctuation is due to natural tendencies of animals and lower summer feeding costs. Animals naturally cost more to keep in winter. And yet the farmer is penalized for overproduction during the cheapest period of production, summer. Since the producer has no control over either the price or quantity produced by the industry, the only side of production over which he has any control is the cost of production.

In 1980, Manitoba's Conservative Government passed *The Milk Prices Review Act*. The Act created the Manitoba Milk Prices Review Commission (MPRC) which ruled that as of January 1, 1981 price controls at the consumer level would be abandoned and a trial period, of allowing retail prices to be established in the market place, would be instituted. The competition that resulted from this action further reduced the number of players in the dairy-processing field. Unless a company they had huge volume sales, or contracts with major grocery chains, they had trouble remaining competitive.

Milk is graded either Grade A or B, which is determined by its bacterial count. Grade A must have a bacterial count of less than 100,000 per millilitre, as determined by the plate loop count and be produced in facilities that meet a minimum standard. Grade A milk is mainly used in drinking products while Grade B is used for manufacturing dairy products. Grade B milk may have a bacterial count of not more than 200,000 per millilitre. Grade A milk can be used in any class of production but Grade B is limited to Classes III-VI. The Milk Control Board controls the price at which milk can be sold to consumers (as opposed to manufacturers), and the price paid to producers for Class 1 milk. When the Manitoba Milk Producers' Board believes the price of Class 1 milk needs an adjustment, it makes an application to the Milk Control Board, which institutes public hearings before the price can be changed.

The Manitoba Milk Producers (MMP) negotiates industrial prices with processors. They establish the price producers receive for industrial milk. They also make adjustments to reflect changes in federal support prices at which CDC offers to buy certain dairy products. Multiple Component Pricing was implemented in Manitoba in January 1993. This system pays producers and charges processors for the milk components (butterfat, protein, solids). It was intended to provide a more market responsive pricing system, and to bring about greater equality in milk pricing for both producers and processors, since producers will be more accurately compensated for the true value of the solids in the milk they supply. Conversely, processors will pay according to the components in the milk they receive.

The MMP also negotiates transportation rates for Manitoba producers and contracts with bulk milk transporters.

THE BEGINNINGS OF THE DAIRY INDUSTRY

In the early years of the province's history, farmers produced only enough dairy products to feed their families. Any slight surplus of milk, cream or butter was sold directly to a purchaser, usually a neighbour or a local storeowner. Until the last decade of the nineteenth century, there was no great incentive in Manitoba to increase dairy production because there was very little market for the product. With the growth of Winnipeg and the creation of transcontinental railways making Winnipeg an entry point to a huge hinterland, that situation changed.

It was the Mennonites who first began to produce excess dairy products for sale. Beginning in the late 1880s, Mennonite farmers began making trips to Winnipeg to market surplus farm products. These included wheat, eggs, milk, butter, pigs, chickens and beef. According to a table for prices for these products in 1895, milk paid 70 cents per hundredweight.²⁴ While the sale of cream and butter brought needed cash into pioneer farms, the facilities to produce dairy products on a large scale were lacking. One pioneer wrote that, in 1918, his family started with one-quarter section of land and a few Ayrshire cattle. The little bit of grain produced was used to pay off debt incurred by buying machinery and for loan interest. They separated the milk morning and night, lowered it down the well to keep it cool, and sold it to a creamery a few miles away. Occasionally they received as much as \$5.00 for a five-gallon can of cream and this, along with the sale of a few dozen eggs during the summer, was all the cash income the family had.²⁵ However, for a farmer near Winnipeg who could put the capital investment together to start a dairy, creameries in Winnipeg were ready to offer contracts for the raw milk and cream. In fact, in their early years, the creameries in the city sometimes had to import milk from the United States.²⁶ An enthusiastic writer predicted the potential for Manitoba to become a dairy province in 1895:

Manitoba land is cheap and much of it is ideal for dairy farming, good water supply that will grow corn, alfalfa, peas and almost every kind of cultivated grain and grass. It will also grow finer root crops than anywhere in the world. There is an abundance of grazing and hay that can be obtained for the cost of putting it up and hauling. And most important of all, there is the finest market in the world right in their own Province where the highest prices can be obtained for milk, butter, cream and poultry, in the rapidly growing Western Metropolis City of Winnipeg.

Within from 20 to 30 miles of the City of Winnipeg, land can be now purchased from \$20 to \$30 an acre, and that will grow 20 tons of corn, 3 tons of alfalfa or 70 bushels of oats to the acre.²⁷

In 1880, W.A. McAllister of Stoney Mountain created the first strictly dairy herd in Manitoba, consisting of Ayrshires. It was the first of many to be established within the Winnipeg milk shed area. Before long there were cheese factories created in developing communities. S.J. Jackson in Stonewall built the first, the Rockwood Cheese Factory, in April 1882. The same year another cheese factory opened in Rapid City but it closed in 1885 when its operator enlisted in the forces to suppress the North West Rebellion. Only with the arrival of special equipment that could separate cream from milk could creameries be opened. In 1885, the Wakopa Creamery Association, organized in the Boissevain-Turtle Mountain area, acquired a cream separator from Sweden that could take the milk from 20 cows per week and produce 70 pounds (31.7 kilograms) of butter.²⁸

Thereafter, the proliferation of cheese factories and creameries across the expanding frontier of Manitoba prompted the Manitoba Government to pass *The Manitoba Dairy Act* and create the Manitoba Dairy Association in 1886.²⁹ In June 1886, the Government sent Professor S.M. Barre traveling to communities to lecture on the advantages of creating a dairy herd, and to help communities to create creameries.³⁰ The amount of butter being produced demanded that some attention be paid to the quality of these products.

In order to provide milk for their children, most farmers kept one or more cows. The separated or skimmed-off cream was used by the family and for butter making. Any excess could be sold to the local creamery once a week. When the Depression hit in 1929, it was natural for dairy herds to be increased since the drought in some parts of the country limited the variety of crops that could be produced and whatever crops that could be grown had to be sold at such low prices. In the 1930s, many families' only cash income came from their regular cream cheque.

In 1937, the creation of the Milk Control Board brought changes for the milk producer. Many of the dairies that delivered milk directly to consumers now chose to ship their product to processing plants instead. This precipitated a change in storage methods on the dairy farm. The milk had to be properly cooled before the plant accepted it. Some people cooled the milk by placing the cans in tanks of cold water. Another method was a Flash Cooler. Cold water was pumped through metal tubes and milk was poured into a trough at the top from where it dribbled down through the tubes and ended at the bottom, cooled. It was then put into the milk cans and taken to the processing plant. But even this process involved more labour than would be available in a few years.

With the second World War and the urbanization process that followed it, many families lost their labour pool. Mechanization of agriculture led to the disappearance of livestock from the farm. If a farmer no longer had to keep horses for labour and could purchase milk at the local

store, why would he keep a few cows for milk? In the post-war economy, grain crops were marketable, and dairy farming became an all or nothing proposition. Between 1945 and 1959, four factors influenced the changes in the dairy industry: profitability of grain production, price of milk, availability of labour, and technological advances in dairying. Grain production and dairying were actually in competition with one another in this period and unless a farmer had a labour supply, or the money to modernize so he needed less labour, he would probably choose the grain production route. Many milk shippers who lived on land not suited to grain production chose the dairy route and opted for milk quotas to keep up the supply of whole milk to Winnipeg. After 1950, as grain prices began to fall and milk prices increased, many dairymen opted to increase the size of their herd, improve production per cow and mechanize to make their dairy operations more financially sound.

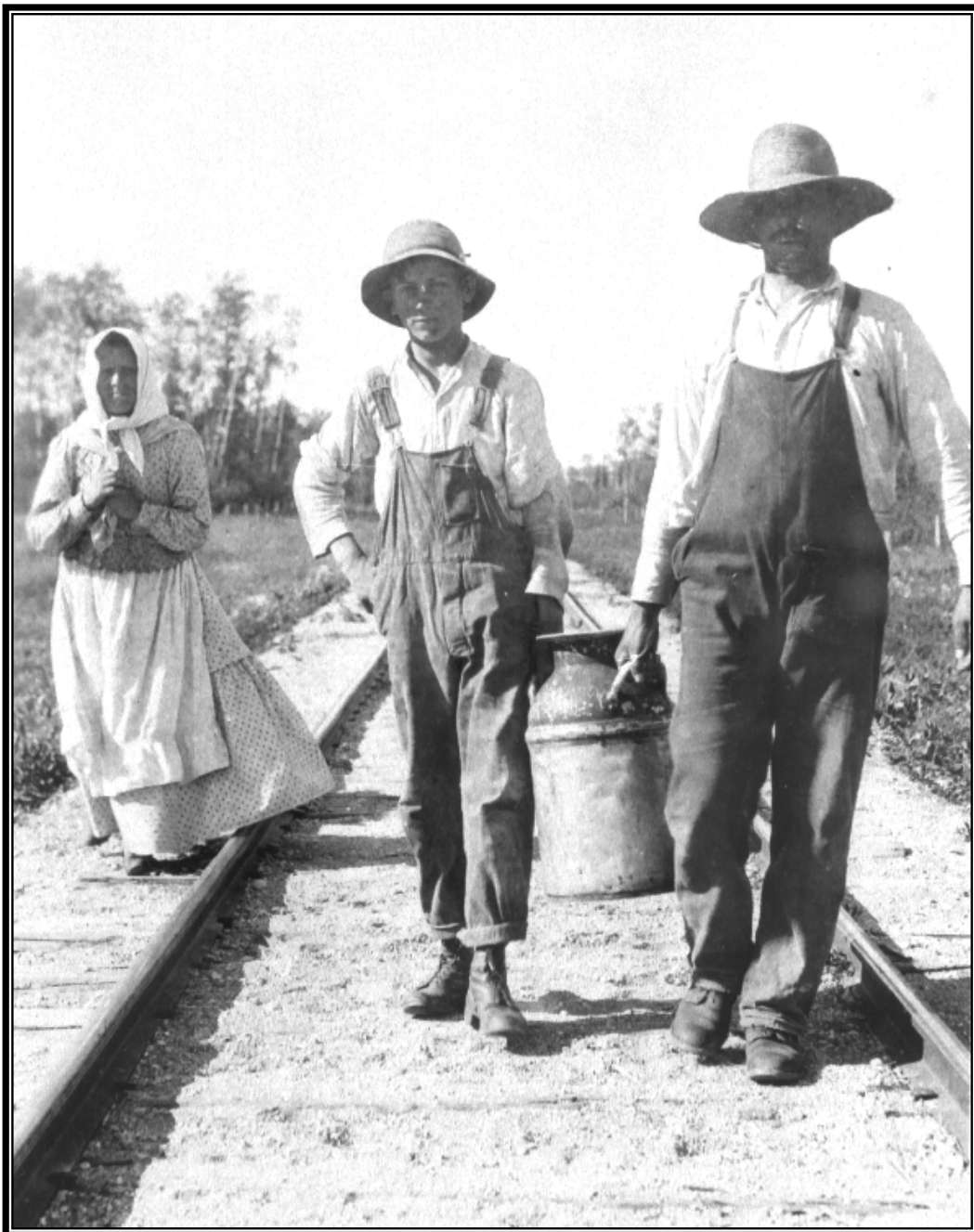

Ukrainian settlers carrying cream can to railway station. Taking the cream to the railway station was an essential task for this Ukrainian immigrant family. Often the only cash income these families had came from shipping cream. Source: PAM, J.W. Sisler Collection

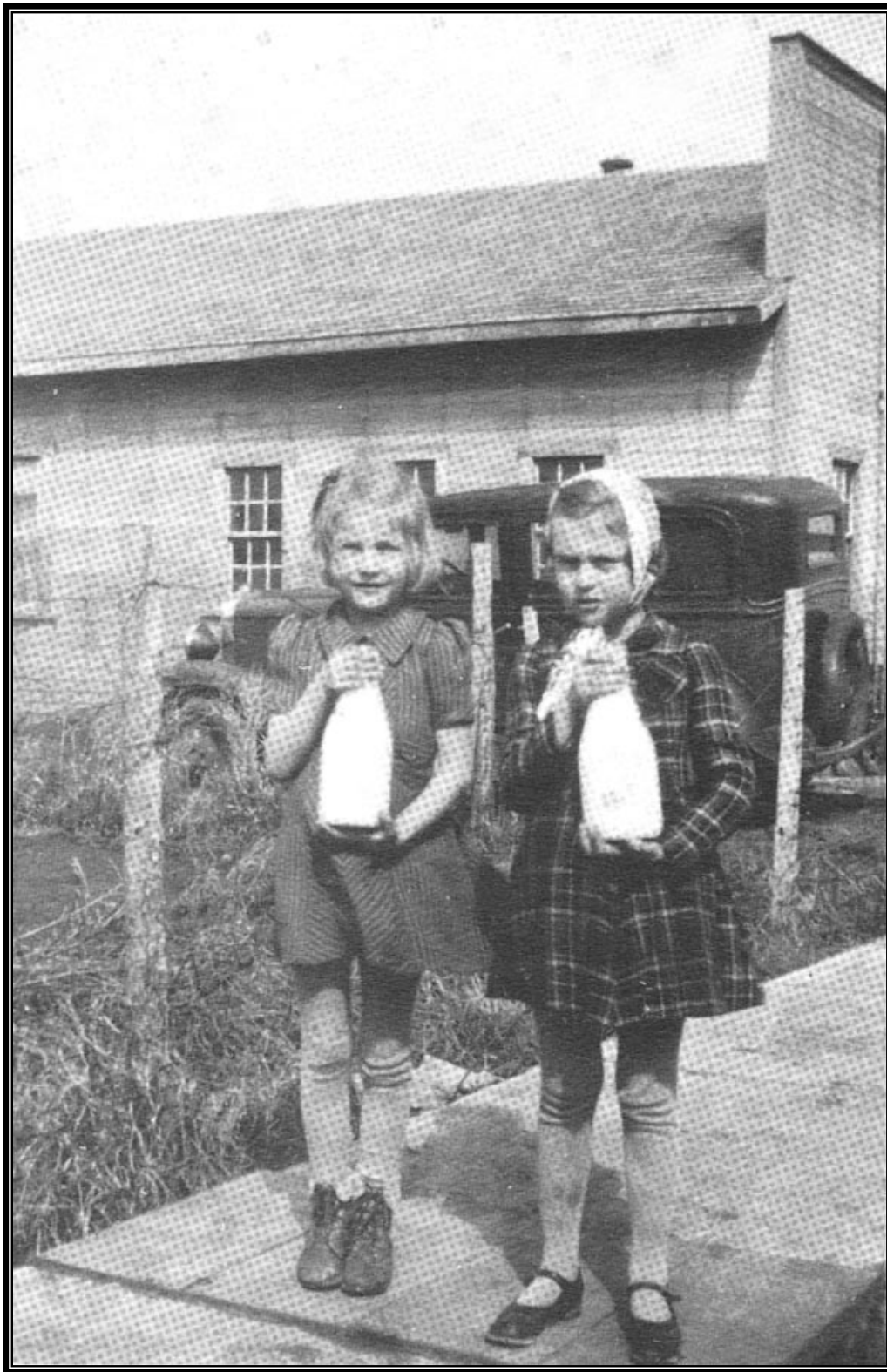

“Going for the milk” was a popular task for children. Every morning or evening a family living in a village had to collect fresh milk from the local dairyman. Some towns had milk delivery. The introduction of refrigeration and rural electrification in the 1950s changed this daily pattern.

Source: Horndean Reunion Committee, *Horndean Heritage*, 1984, p.118



Cattle grazing in the Interlake region
Source: Provincial Archives of Manitoba, Ledohowski Collection

If a decision to choose the dairy route over grain growing was taken, considerable expense was needed to modernize the enterprise with labour-saving devices. In 1969, the Federal Government set up a task force on agriculture. One of its recommendations was for the Canadian Dairy Commission to:

assist milk producers to adjust their dairy enterprises so that the latter became profitable without extensive subsidies or to assist milk producers who have little prospect of financial success as dairymen to phase out of milk production and into other operations with the least possible personal and social dislocation.³¹

In response, the Economics Branch of the Manitoba Department of Agriculture sponsored a program of Farm Conservation Grants and Farm Diversification to help farmers make the transition. Courses on dairying, as well as diversification loans, were offered.³²

Over the next ten years, this phasing out process resulted in the reduction in Manitoba of manufactured milk, cream, and fluid milk shippers from 17,181 to 5,632 in 1977.³³ The greatest reduction was in cream shippers and the greatest increase occurred in the fluid milk shippers who more than doubled over the ten-year span.³⁴ The strongest factor in creating these changes in dairy production was the supply management program instituted by the Federal Government.

SPECIALIZED DAIRY FARMING

In 1967 Manitoba, although an agricultural province, did not produce enough milk products to feed its people. That year 200 million pounds (90, 719 metric tons) of milk were imported from Eastern Canada. Rationalization of the industry meant that between 1962-67 the number of processing plants and number of dairy farmers dwindled. The number of processing plants dropping from 60 to 40.³⁵

This change symbolized the transformation of dairy farming from a mixed-farming economy to a specialized phase in which dairy farms were run as a business. All cattle were expected to pay their way, so to speak. A cow had to produce enough milk to pay the costs of feeding, housing and maintaining her in top medical condition. Her life span was considered to be six years, in which time she would have four lactation periods. In 1959, Manitoba Department of Agriculture advised dairymen that to create a net income of \$5000 a year they needed 33.5 cows producing 300 pounds (136 kg), 20 cows producing 400 pounds (181 kg), or 13 cows producing 500 pounds (226.8 kg) of butterfat per year. At that time, the highest producer of butterfat in the Steinbach area was annually averaging 459.2 pounds (208 kg) of butterfat from 13,860 pounds (6285.7 kg) of milk.³⁶

DAIRY HERD IMPROVEMENT TECHNIQUES

As early as 1905 the Record of Improvement (ROP) system had been initiated by the federal government, at the request of the Breed associations. Supervised by the federal Livestock Division, this program provided production certificates for each cow entered on tests. The tests consisted of weighing and sampling milk and were carried out by Manitoba Agricultural College, until taken over by the federal Dairy Branch, and after 1921, the provincial Dairy Branch. The milk production of each cow was monitored, and the number of cows tested increased annually, from 1784 cows to 5,800 cows in 1975. There was a charge to farmers for the tests, ranging from \$3.00 per cow to a \$100.00 minimum cost.³⁷ The number of dairy farms with registered

cows increased greatly as a result of this program. Farmers on the ROP program, who weighed and tested the milk of their cows, were allowed to sell their registered bulls.

The Department Dairy Herd Improvement Association (DHIA), started in 1947, involved dairy specialists assisting producer groups to improve management of dairy breeds. Under this program, the milk producers formed a Dairy Herd Improvement Association which would hire a technical supervisor to visit member farms once per month to test each cow for milk and butterfat content. Those cows with good statistics became valued breeders. The Department of Agriculture offered an annual grant to each association and the balance of the technical supervisor's salary was paid by the producers. Where associations did not exist, a program was developed in 1959 to allow farmers to take samples from their own cows and send it to the Animal Husbandry Branch for evaluation and charting. Local DHIA's became prevalent by the 1950s, and these organizations improved production by selective breeding and specialized feeding. By keeping records for each cow it was possible to eliminate cows producing inadequate amounts of milk and butterfat. By using these selective breeding procedures, the amount of average milk production rose from 8000 pounds per cow in 1947 to 19,000 pounds in 1995.³⁸

A second successful breeding program was Artificial Insemination (AI), which is prevalent today. The artificial insemination industry, under the supervision of the Manitoba Department of Agriculture, began in Manitoba in 1941. Facing opposition from the Pure Bred Beef Breeders, it was decided that the creation of bull stud farms for dairy bulls would be more acceptable to Manitoba cattlemen at that time. A series of breeding co-ops, beginning with the Rat River Breeding Co-op in 1944, were established with government subsidies in the dairying regions of Manitoba. The dairy herds were improved by impregnating the dairy cows in the region with the semen from the pure-bred dairy bulls. The Rat River Breeding Co-operative Ltd., with the support of the Manitoba Government, established a bull barn on the property of Emile Hebert, a dairy farmer in the St. Pierre area who had first used artificial insemination on his own dairy herd in 1944. The semen, from three fine bulls Hebert purchased from the Raymondale Farms in Quebec, was sold to other breeding cooperatives across Manitoba. The demand was so great that eventually the Rat River centre was not able to meet the demands of all the breeding units in the province. During the 1950s the first semen frozen in dry ice and alcohol was purchased from Ontario by Thomas Bruce of Stonewall, and by 1955 the Stonewall Artificial Breeders became the first association to use 100% frozen semen. Gradually all the breeding associations switched to using frozen semen.³⁹

By the 1950s a system was developed for freezing bull semen in liquid nitrogen, which gave it an indefinite life, and added more choices of sires and a broader coverage. In 1958, Dr. K.H. Robson of Selkirk, who had developed his own bull stud for the Beausejour - Whitemouth area in 1952, was the first to import the semen in liquid nitrogen from a source in Wisconsin. For almost 15 years, Dr. Robson operated a semen distribution system all across the prairies, training over 50 technicians in Manitoba alone. In 1962, his organization performed 41,000 services. In 1973, Robson's equipment was acquired by the Manitoba Semen Distribution Centre which obtained the sole right to distribute semen in Manitoba.⁴⁰ The artificial insemination program made it unnecessary for a farmer to purchase an expensive purebred bull, or haul his cow a distance to spend time with a neighbour's bull. By paying a fee, a dairyman had a choice of semen from high quality bulls to improve the quality of his herd, without the bother of leaving his own farm.

To create the kind of cows that produced great quantities and qualities of milk, records for cattle became computerized and matches were made between proven sires and dams. The National

Identification Program was created in 1972 to find these matches. With the Artificial Insemination Program, it was easy to breed a dam in Manitoba with a sire in Quebec, for example. The better the pedigree of the sire, the higher the price for the semen. The combination of good breeding and specialized feeding brought desired results: the average cow production in Steinbach rose to 14,000 pounds (6223 kg) of milk in 1980 from 9000 (4,250 kg) in 1955.⁴¹

Building on the success of the AI program, new techniques allow embryo transfer, embryo freezing, and embryo cloning. Good breeding cows are stimulated to produce an exceptional number of eggs at one time. These eggs can be frozen and transferred to the uteruses of less important cows. In other words, many cows can be used to breed the eggs of the exceptional cow. The same process is used for the sperm of exceptional bulls. The sperm and embryo can be brought together in a lab and then placed in ordinary cows for production. Today, embryo sex selection is also being used to improve production.

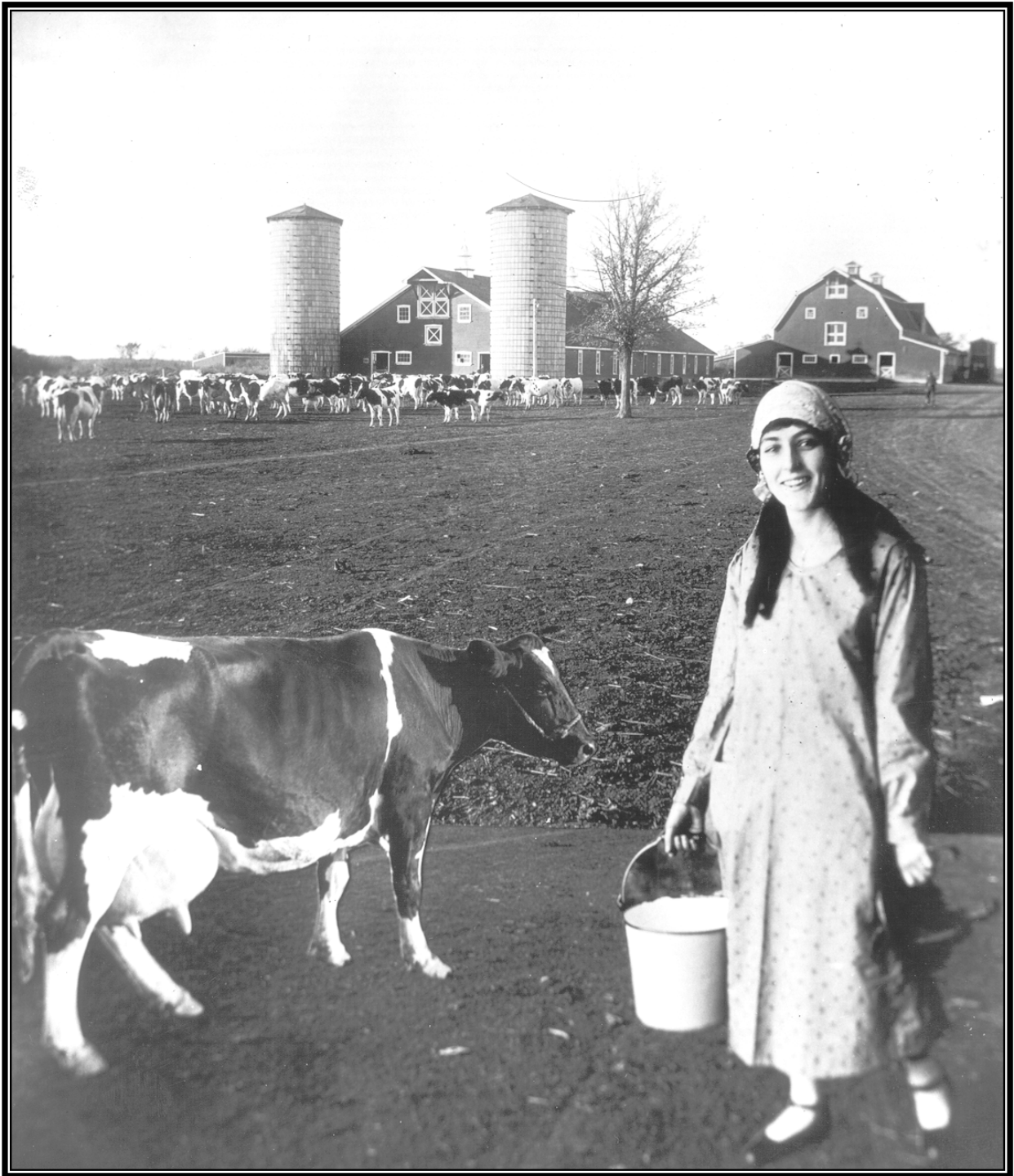

This is a 'doctored' photograph, prepared as a promotional piece for the dairy industry. The dairy cattle are Holsteins. The dairy farm in the background is the Cummings Dairy Farm near Winnipeg. Source: PAM, Jessop Collection 44, #N3103

MODERNIZING FARM TECHNIQUES

A switch to bulk milk delivery was spurred by two factors: disease control and efficiency. The bulk system led in 1974 to pooling of all milk collected, and this meant that all the milk must be uniform in quality. Not all producers welcomed the change because attainment of standard quality and efficiency involved a considerable amount of investment. When the creameries began to phase out the receiving of cream or milk in cans, dairymen had no choice. Barns had to be adapted or rebuilt to facilitate mechanized milking. Beginning in the 1960s, free-stall-housing concept barns became popular. The barns were also modernized with pipelines that took the milk directly from the cow's udder to the bulk tank, greatly reducing the chances of any bacterial contamination.

Cattle feeding techniques changed as well. Grassland Societies were introduced by the Agriculture Department in the 1970s, the first being in the St. Claude area.⁴² Their purpose was to improve grazing practices and hay quality. Large upright steel silos became familiar sights on dairy farms as cattle-feeding was modernized. Varieties of forage, from corn, alfalfa, Sudan grass, and sweet clover, could be deposited in them and kept at peak moisture content (25-30%) to provide optimum nutritional value. In addition, the cattle began to be given protein supplements, vitamins and minerals. Today, few cattle are allowed the luxury of pasture grazing.

The most distasteful job faced by a cattleman, the removal of manure, was made easier by the development of liquid manure systems. In modern barns, the cow droppings fall into a pit and are piped out by a vacuum into a machine that liquefies it for spreading on the farmer's fields as fertilizer.

While mechanization has made life easier for a dairy farmer, it has also made it more expensive. A farmer cannot expect to enter or compete in the milk production field without the capital to build modern milk sheds and maintain a well-bred herd. Nor is it a business for the uneducated. Today's dairy farmer must be able to operate complicated computerized machinery, and keep computerized records of his herd's production. Consequently, dairy farms tend to be a family business, with several generations involved.

MILK SUBSIDIES

While the milk-producing industry went through a metamorphosis, so did the milk-processing industry. Until 1967, Manitoba lacked a subsidy program for the processing of manufacturing milk, and could not compete with Ontario and Quebec, which offered subsidies to manufacturing milk producers. In 1967, our sister provinces dispensed with the subsidy, at the same time that the federal government raised its subsidy for butterfat from 21.43 cents per pound (per .45 kg) to 31.42 cents per pound (.45 kg), making dairy farming more attractive than it had been since the war years. The quota was tied to figures for 1966 production and a special opportunity was created for those who had not delivered 50,000 pounds (22,675.7 kg) of milk that year. The maximum quota qualifying for a subsidy was set at 300,000 pounds (136,054 kg) of milk. The subsidy program had a culling effect on many of the smaller producers while allowing the larger producers to increase production.

The new subsidy program led to the opening of a manufacturing milk plant in St. Claude, 65 miles (104 km) southwest of Winnipeg, in a French-speaking district with a tradition of dairying. The plant was completed in early 1967 and more than 130 farmers, within a radius of 90 miles (144 km), signed contracts to supply milk to this new Modern Dairy milk factory. The plant, with

a capacity to handle 200,000 pounds (90,909 kg) of milk per day, produced 2.3 million pounds (1,045,454 kg) of butter, and 4.5 million pounds (2,045,454 kg) of milk powder per year, or the equivalent of 85 per cent of all milk consumed in Winnipeg.

KEEPING MILK PRODUCTS SAFE

Because diseases can be passed from cattle to humans through milk consumption, keeping dairy cattle free of disease became an essential health policy after the pioneer period. Until well into the twentieth century, however, no system of checking conditions under which milk and dairy products were produced existed in Manitoba. Kept in low, poorly ventilated cowsheds, cattle certainly were at risk of infecting each other. Milk was not tested for disease or bacteria. Certainly, without electrification and refrigeration, the only method of keeping milk cool enough to prevent bacteria counts from rising was placing it in a well. If the cream or milk can upset in the well, the result was a contaminated water supply. The cleaning of the well, after cream had spilled into it, was a horrendous job. No wonder, that farmers often chose instead to keep the cream or milk can sitting in a water trough from which cattle drank, but into which cold water was intermittently pumped from the well.

There was very little inspection of dairy farms before 1910. At that time, however, two men were appointed by the City of Winnipeg to sample milk for butterfat testing and to visit dairy farms. By 1918, testing for bacteria in milk had begun. In 1929 the Manitoba Government started licensing milk producers who shipped to Winnipeg pasteurization plants. Finally, in 1939 the connection was made between dairy farm inspections and health when a milk and food inspector was appointed under the Department of Health. From 1951-1972, inspection of milk plants and dairy farms was centralized under the Department of Health. Since then it has been the responsibility of Manitoba Agriculture.

The first bacterial test for milk in the 1930s was the "Methylene Blue" test, so called because good milk would remain blue for five hours; bad milk turned red or purple. That would mean it was fit only for processing into butter or other by-products. The "Blue" test was replaced with the Resazurin Test, which identified poor milk within an hour. In 1964, the Standard Plate Loop Count replaced the Resazurin Test.

It was important to keep the bacteria counts low, but also important to try to reduce diseases spread by milk, such as scarlet fever and diphtheria. The most prevalent disease spread by milk was tuberculosis.

Testing for tuberculosis in cattle began in 1920 but was not widespread until much later. In 1922, Dufferin Municipality (around Carman) was chosen by the federal Health of Animals Branch to be the first TB free area in Canada. In nearby Grey Municipality, 480 herds were tested for tuberculosis in 1925. Of the 65,000 cows tested in that area, 55 were found to be positive, and these were shipped to stockyards.⁴³ The test program was increased to cover all municipalities by 1950, and in March 1959, the Provincial Government requested the federal authorities declare the entire province a Bovine Tuberculosis Restricted area. In a restricted area, all cattle were tested for TB and any that reacted positively were irreversibly marked in the right ear, and ordered to be isolated from the herd. Their milk could still be sold to a pasteurizing plant but could not be sold unprocessed. After 1940, diseased cattle were slaughtered under controlled conditions. The carcass was inspected for disease before it could be sold.⁴⁴ Their owners were compensated for the financial loss.

Another disease of dairy cattle was brucellosis, which caused pregnant cows to abort, causing financial loss for dairymen. A federal program to control brucellosis in both beef and dairy cattle began in 1950, with a vaccine offered to the provinces, who in turn paid veterinarians to administer it to calves between four and nine months old. To encourage herd owners to embrace the program, they were paid fifty cents for every calf vaccinated. Municipalities were encouraged to pass by-laws making calf vaccination compulsory. In 1957, the federal government began an eradication policy by creating brucellosis control areas where cattle were tested, and infected cattle slaughtered. Cattle from outside the control regions had to test negative before they could be imported to the brucellosis-free zones. After 1967-68, when 131 such districts existed in Manitoba, the vaccination program was abandoned in favour of the test and slaughter program. Such policies have greatly strengthened the quality of cattle herds in the province.

Mastitis, although it does not threaten the quality of the milk produced, is a serious threat to the quantity of milk produced by a dairy herd. An inflammation of the udder, mastitis is the most costly disease of a dairy herd and it was estimated, in 1979, that 50% of dairy cattle suffered from it.⁴⁵ The almost universal use of milking machines has intensified the problem, causing experts to set up studies to examine possible changes in milking techniques that could reduce the problem. The best approach to controlling mastitis includes routine testing, dipping teats after milking, using dry-cow therapy, and practicing good animal husbandry for cleanliness. Cows diagnosed must be treated immediately if the udder is to be saved. Most treatments involve infusing an antibiotic into the udder through the teat canal. Chronically infected cows must be sold.

TECHNOLOGICAL INNOVATIONS

PASTEURIZATION

In 1864, Louis Pasteur discovered that heat treatment could kill pathogenic bacteria, and for the next fifty years this was the most common way to treat milk in dairies. The first compulsory pasteurization law was passed in Chicago in 1908. The first pasteurized milk in Canada was produced in Montreal in 1900, but the process was not very successful. In 1906, the Ottawa Dairy started to pasteurize and bottle milk. In Manitoba, the first dairy to pasteurize milk was the Crescent Creamery in Winnipeg, in 1907. Pasteurized cream was produced in Shoal Lake in 1897 but the cream was used for butter. The process used in these instances was the holding method, whereby the milk was heated to 145 degrees and held for 30 minutes before cooling. A later method, called the High Temperature, Short Time (HTST) called for heating the milk to 161 degrees and holding it for 16 seconds before cooling. A more recent process is the ultra high heat process (UHT). The use of vats with copper coils gave way to spray vats and jacketed vats with agitators, to the plate type heat exchanger, and then to the regenerative system of heating and cooling.⁴⁶

In 1977, the dairy industry in Manitoba began using the UHT process, whereby milk is sterilized by continuous flow and heated to at least 266 degrees for two seconds before aseptic packaging. This process, when applied to various dairy products, allows them to be kept at room temperature for several months. This is a valuable process for preparing dairy products to supply remote regions with scattered populations, as in northern Manitoba.

THE BABCOCK TEST

In 1890, Dr. S.M. Babcock of Cornell University developed the Babcock test to determine the butterfat content of milk and cream. Sulphuric acid is added to a sample of milk in a flask, and centrifugal force causes the butterfat to collect in the calibrated neck of the flask. This test soon became the official standard for creating an equitable system for purchasing milk from farmers. Individual cows could be tested to determine the richness of their milk and allow farmers to select high-producing cows on this basis. S.M. Barre introduced the Babcock test in Winnipeg in 1899 at the Winnipeg Creamery and Produce Company. Although other types of tests were developed later, the Babcock test was the standard for 75 years.

HOMOGENIZATION

The homogenization process, whereby fat globules in milk are broken down and evenly distributed throughout the milk, was first used and patented in France in 1902. It was not successfully used in Canada until 1927. The regular butterfat content found in homogenized milk is 3.25 %. In the last 25 years, this content has been altered to produce milk with lower levels of butterfat, all the way to skim milk, which has no butterfat, to suit modern dietary regimens.

Today the fluid milk plant is highly automated with a master panel. The milk from large, holding tanks is directed by push button through automatic valves to the clarifier, and separator, pasteurizer and homogenizer and finally to the packaging machine. Although plastic pipes were introduced in 1965, stainless steel pipes are still standard for carrying the milk through the pasteurization process.⁴⁷

PACKAGING

As late as the 1930s, milk was distributed by ladle from milk cans directly into consumers' milk pitchers. It has since undergone a series of packaging changes, some instrumented for health reasons, some for the convenience of the producer or the customer. The first package was the round glass bottle, which became common in the 1920s. The square bottle with a shorter neck replaced this. Surprisingly, it wasn't until 1961 that a paper hood was placed over the cap of the glass bottle. This prevented germs from forming along the edge of the cardboard caps which were used to close the reusable glass bottles. The idea of placing the milk in a plastic coated paper carton came from Europe (Sweden). Safeway introduced it to Manitoba in 1951, and it was a hit with the customers because it was lighter to carry, did not need to be washed and did not require a deposit.

Even though this new packaging was very expensive compared to glass bottles, despite the latter's cleaning and breakage costs, other dairies had to follow suit or lose customers. Crescent Creameries ordered the machinery for "Pure Pak", without informing the other creameries, who all had a gentleman's agreement not to switch to paper cartons. When J. Spiers of Modern Dairies heard that Silverwoods was importing a "Pure Pak" container to fill Imperial quarts, he beat them to the market by ordering a machine from the United States that filled the smaller U.S. quart. Silverwoods reacted by cancelling their order for the machine and they continued to use glass bottles long after other companies had adopted the new cardboard packaging. The People's Co-op lost so many customers during this battle they had no choice but to order the new technology. They even hired Modern Dairies to custom package their milk until the new equipment arrived three and one-half months later.⁴⁸ By 1955, 80% of all milk sold in Manitoba was in cardboard containers.⁴⁹

Silverwoods introduced the plastic pouch, or milk in a bag, to Winnipeg in 1969 and Art Rampton of Dauphin introduced the three-quart jug. In 1964, the popularity of three-quart jugs was stimulated by the fact that Mini Marts began selling them at a cut-rate price. Once more, the dairy processors had to scramble to purchase the machinery for this new packaging. With the adoption of the metric system in Canada in the 1970s, the size of all these packages was reduced to one, two, or three litres.

The packaging of butter also underwent tremendous changes. In the pioneer days, butter was packed in wooden tubs, which, unless well soaked in water to draw out the taste of the wood, always had a slight taste of whatever it had been stored in for a long time. Clay crocks were the next storage container. Often a five or ten-pound (2.26 or 4.5 kg) crock went directly from a farm kitchen to a private customer's home. If it was well washed, and worked free of buttermilk, packed in a crock and covered with a layer of salt or brine, the butter might be preserved into the winter.

To work a large churning and turn it into butter was a heavy job, usually performed by the women in the household. The advent of creameries with large commercial churns removed this laborious job from the home to commercial establishments. The creameries used machines which could cut the butter into squares and wrap it in parchment paper.

CREAM SEPARATOR

The principle of using centrifugal force to separate heavier portions of liquids began about 1000 years ago, with the Chinese whirling a gourd filled with fruit juice around their heads to cause a separation. In 1853, this same principle was used to extract molasses from crystal sugar. In 1859, a German scientist applied this method to extract cream from milk. The Germans were the first to develop and market a machine that used a centrifugal separator to separate cream. In 1877, Ledfeldt and Lentsch marketed a machine which used a hollow bowl, running at a speed of 600 revolutions per minute, to produce a thick ropy-like cream which was then ladled off.

Swedish engineer, Gustav De Laval, in 1877, invented the first continuous centrifugal separator. He perfected the machine and patented it in Sweden in 1878, and in America in 1879. His machine, for which the patent covered only the type, not the principle, had "a hollow bowl with wings attached to the peripheral surface to force the milk to travel with the same number of revolutions as the bowl. The machine revolved at a rate of 6000 revolutions per minute and had a capacity of 300 pounds per hour" (136 kg per hour).⁵⁰

Professor Barre was sent to Denmark by the Quebec government in 1879 to study Danish dairy methods. Here he saw the centrifugal separator at work and was the first Canadian to purchase such a separator and install it in a creamery in Beauce, Quebec.⁵¹ Walter Clifford of Austin, brought the first cream separator to Manitoba when he purchased a De Laval separator from Sweden in 1885.⁵² Driven by a small three-horse power engine, powered by 40 pounds (18 kg) of steam, this machine was capable of separating 60 gallons (270 litres) of milk per hour.⁵³

QUIT Wasting Cream Profits

NINE out of ten dairy farmers are actually throwing away \$20.00 per cow per year! They are doing it by using wasteful, inferior cream separators—or, even worse, by clinging to the old-fashioned gravity, shallow-pan method of separation. Stop this cream waste at once on your farm.

Get ALL the Cream—Use a **VIKING CREAM SEPARATOR.**

Over One Million In Use! Each Viking Guaranteed For a Lifetime! Greater in capacity than any other separator of equal rating. Easiest operated and easiest cleansed separator on earth. Lower in price than other standard separators—because it is made in the World's Largest Separator Factory. See the Viking at your dealer's.

Over One Million In Use

Send For These 2 Free Books
Full of profit-making plans for dairy farmers. Quick shipment always assured from warehouses at 9 different distributing points throughout Canada.

Swedish Separator Company
Dept. Z
507 So. Wells St., Chicago, Illinois

Swedish Separator Company,
Dept. Z, 507 S. Wells St., Chicago, Illinois
I want those two free books—send them to me at once.

Name

R. R. No. Post Office.....

State..... My Dealer's Name Is.....

The many advertisements for cream separators placed in agricultural Magazines are an indication of the large market that existed for these machines in the early 20th century.

Source: *Western Home Monthly*, Nov 1917, p.36

MELOTTE CREAM SEPARATORS

are the cleanest skimmers yet produced, the bowl is fitted with a special separating device which enables the largest possible quantity to be separated in the shortest possible time with the greatest efficiency. We have much indisputable evidence of the hard wearing qualities of the Melotte.

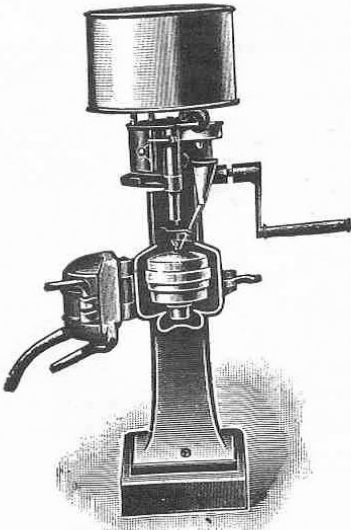

Melotte Cream Separator Co., Ltd.

WINNIPEG CALGARY

W. ANTLIFF, Manager

Agents for "Ideal" Gasoline Engines

Another cream separator advertisement The Viking was sold by the T. Eaton Co. and would therefore have been purchased through the catalogue by many rural families.

Source: *Northwestern Farmer*, 5 November 1918, p.1419

When you need more capacity —
**Which would you rather
 pay for?**

SOONER or later in these times of change you are up against the problem of an increase in capacity for skimming. Which would you rather pay for—a whole new separator, or a new bowl and fittings only? With other machines you must buy another entire machine to increase capacity. The day you get your

Renfrew

you can forget your capacity troubles; increase your herd and you simply send for larger bowl and fittings, returning old bowl. You pay the difference between the sizes. The one frame does for all capacities.

The change of capacity is not accomplished by merely changing the skimmer. On the contrary, our new patented interchangeable bowl casing permits bowl to be changed completely. Each bowl is proper capacity for the work it has to do, not a makeshift.

This interchangeable capacity feature, in perfected form, is obtainable only in the Renfrew. It is making a hit with dairymen. Alone it would make a big appeal, but the Renfrew also gets quality butter fat and more of it than others. This is due to its exclusive curved-wing centerpiece and wide open bowl. The Renfrew saves all but 1/10 of a pound, less than 7 cents worth lost in 1000 lbs. of milk skimmed. It runs easy and is the easiest machine of all to clean.

All these big features mean both convenience and real gold dollars saved right along. The Renfrew catalogue explains all; besides, it gives Government Dairy Schools' tests proving close skimming. Write for it to-day.

**COCKSHUTT PLOW COMPANY
 LIMITED**

Winnipeg

Regina

Calgary

Saskatoon

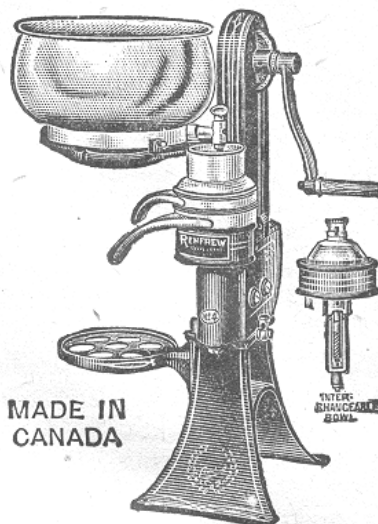

MADE IN
 CANADA

*To change capacity you
 do not have to buy a new
 machine—just
 this part.*

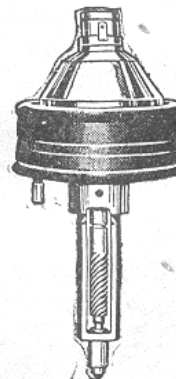

Interchangeable
 Bowl and Spindle

This brand of separator was sold by a farm machinery manufacturer famous for ploughs and tractors.

Source: *The Nor'-West Farmer*, November 5, 1918, p.1418

At first, these separators were large and needed horsepower to operate. In 1895, W.M. Champion gave a paper on the operation of the cream separator to a Dairy Convention.

...Milk must be separated at a temperature of 85 to 90 degrees, ... The cream must be then cooled to 40 to 45 degrees, keeping each skimming by itself until there is enough to churn ...You would think that turning a little faster or a little slower would make no difference, but I find the speed must be regular and according to the printed directions sent with the machine. My own separator is a No. 2 Alexandra. I run it with a 2-horse tread-power using one small horse. The horse stands at an elevation of 15 degrees and walks at a rate of 2 1/2 miles an hour. The power has speed regulators attached and the speed can be regulated as easily as a steam engine. ...There is no reason why a farm cream separator could not be run by wind power..."⁵⁴

Manufacturers began to make smaller machines that could be turned by hand, and separated about 16 gallons (72 litres) per hour. These were more suitable for farmers who milked under twenty cows. The separator required some strength to operate. Preferably the handle could be turned at 68 rpm per hour.⁵⁵ The use of aluminum also lightened the machines and made them more manageable for manual operation. Farmers reported an increase of cream production of about 20 per cent when they switched to a separator from flat pans.⁵⁶

An advertising slogan used by one company said, "It pays to sell a cow and buy a separator."⁵⁷ It was true. The process of producing cream had once taken up to three days, when the cream had been left to rise to the top of milk pans sitting in the milk house; it now was an hour-long activity completed by the women of the household. A story is told about a farmer in the Rathwell district in 1903 who refused to consider the possibility that a machine could separate cream and milk. He gave the salesman a bed for the night but refused to talk about such silly nonsense. In the morning, when the farmer and his men had left for the fields, the farmer's wife asked for a demonstration of the machine. All the women and children watched the contraption perform its magic. The process was a noisy one but it did indeed send cream down one spout and milk down another. The salesman told the lady to hang the skim milk can down the well and he would return the next day, telling her confidently that they would find no cream layer on the top of the milk. The farmer, once shown the proof, purchased the machine, called a "Mikado."⁵⁸

This early machine was equipped with an oil cup which released a drop every few seconds. It also had a clutch, which would slip once in awhile. To correct this, the farmer's wife added a teaspoon of ashes every once in a while.⁵⁹

At the end of the separating process, water was added to the separator to rinse the instrument as the handle was turned. This half-water-half milk residue was fed to the pigs and calves. Once a day the cream separator had to be taken apart and properly cleansed in hot soapy water to kill bacteria. In larger operations lye was put in the wash water. This was a tedious job as the separator had a series of ring-like funnels and two spouts, as well as the large bowl at the top where the raw milk was poured. Many farms, and especially large dairies, had a special room where all this was accomplished, thus keeping the bacteria that was associated with warm milk from contaminating kitchens, and vice versa.

SAVE

~~\$ 10⁰⁰ TO \$ 15⁰⁰~~

\$ 20⁰⁰ TO \$ 30⁰⁰

per cow per year
with a

DE LAVAL
CREAM SEPARATOR

Formerly, with butter-fat at 25 to 35 cents a pound, a De Laval Cream Separator saved \$10 to \$15 per cow per year over gravity skimming.

Now with butter-fat selling at 50 to 65 cents a pound, and even higher, the saving with a De Laval is doubled.

If you have only two cows and are selling cream or making butter, a De Laval will soon save enough to pay for itself.

With butter-fat at present prices you need a De Laval more than ever before, and if you already have an inferior or half-worn-out separator, your cream loss with such a machine is too big to be neglected.

The best cream separator you can get is the only machine you can afford to use these days, and creamery men, dairy authorities and the 2,325,000 De Laval users all agree that the De Laval is the world's greatest cream saver. They know from experience that the De Laval skims the closest, lasts the longest and gives the best service.



Order your De Laval now and let it begin saving cream for you right away. See the local De Laval agent, or, if you don't know him, write to the nearest De Laval office as below.

THE DE LAVAL COMPANY, Ltd.

LARGEST MANUFACTURERS OF DAIRY SUPPLIES IN CANADA.
Sole manufacturers in Canada of the famous De Laval Cream Separators and Ideal Green Feed Silos. Alpha Gas Engines, Alpha Churns and Butter-Workers. Catalogues of any of our lines mailed upon request.

MONTREAL PETERBORO WINNIPEG VANCOUVER

Over 2,325,000 De Lavals in Daily Use.

Another advertisement for De Laval cream separators. Note that it emphasizes how much money the farmer can save.
Source: *The Nor'-West Farmer*, 5 March, 1919, p.312

If a cream separator was not properly cleaned, the machine seized up. One farmer in the Elm Creek area complained to the dealer who had sold him the machine that the machine had malfunctioned after only a few days of use. The dealer visited the farm to correct the problem and found that,

the machine had never been washed after use - so the remedy was a real clean-up job. Many disks were solidly glued together and it was only after the application of much boiling water and prying with the screw driver and butcher knife, they were loosened and cleaned.⁶⁰

The farmer was quite pleased with the renewed efficiency of his cream separator, but "he did imply that such a job of cleaning made it no such labour saving device as the salesman had told him."⁶¹

There were many makes of cream separators used on Manitoba farms, including the De Laval, the Vega, the Renfrew, the Westphalia, the Domo, the Sharples, and the Viking, which could be purchased through Eaton's catalogue. Only one model of cream separator was manufactured in Canada and this was the Imperial. Made in the 1920s, it was marketed by Eaton's for a time. Large machine implement manufacturers such as Massey Harris and McCormick also produced models to sell to their customers. By the 1960s, with the switch to bulk milk sales, the manual cream separator went out of fashion, and their manufacture ceased, making them museum pieces by the 1970s.

REFRIGERATION

Cooling cream after heat treatment required cool water to pass through coils under the cream. This water had to be cooled with ice before it entered the coils. In the early 1920s, small creameries began using ammonia as a coolant in the refrigeration process. Some of the larger creameries had a cooling tower on their roof. In the 1950s, Freon became the dominant refrigerant used in creameries.

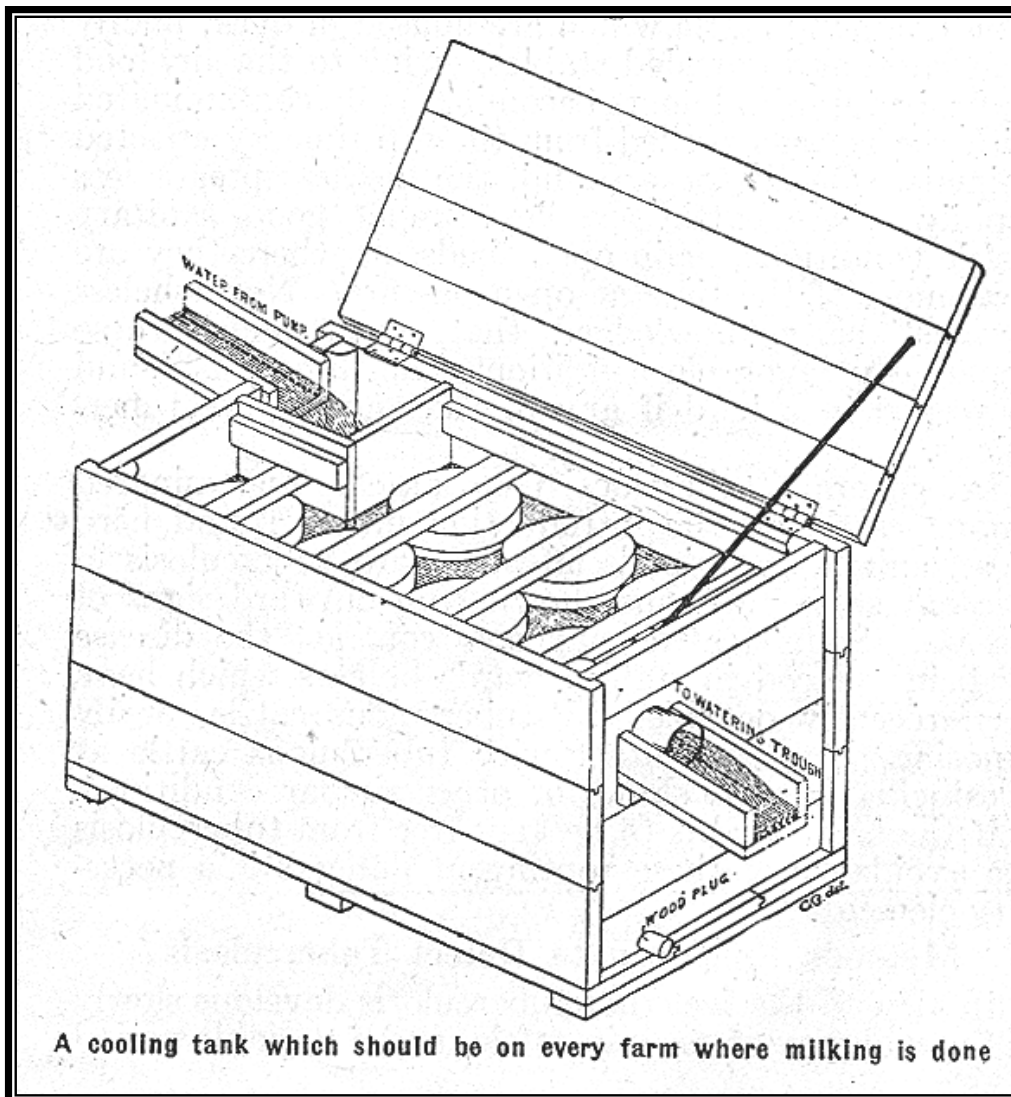

Plans for a cooling tank that a farmer could use for storing milk until it was shipped to the creamery

Source: *Grain Growers Guide*, 19 January 1916, p.7

MILKING MACHINES

Some farmers had milking machines in the 1920s. Run by gas motors, they were often too expensive to operate during the Depression, and, during World War II, repairs were impossible to find, so hand milking predominated until the 1950s.

The milking machine operates on a two-vacuum system: one vacuum is located inside the rubber liner and the other vacuum outside the rubber liner of the teat cup. There is a constant vacuum on the teat to remove the milk and keep the unit on the teat. The intermittent vacuum in the pulsation chamber causes the rubber liner to collapse around the teat. This assists blood and lymph to flow out of the distal teat into the upper part of the teat and udder. After the milking is completed the milking unit is removed manually and the teats are wiped with a weak iodine solution. The suction must be stopped as soon as milking is completed or the cow is at risk of mastitis. The pipes of the milking machine must be properly cleaned and sanitized between milkings.

Modern milking machines are computerized and almost completely automatic.

MILK DELIVERIES

Dairy farmers lucky enough to live near an urban centre delivered their product directly to homes. But a dairyman's life was hard. Until the 1950s, the cows were generally milked by hand very early in the morning because the milk had to be separated, cooled, and delivered by 7:30 a.m. Before 1900, most of the milk delivered door-to-door in Winnipeg was produced and distributed by farmers living in the north end of the city. Many of the employees were Icelandic. Later, Jewish and Ukrainian farmers entered the market. The first Belgians to start dairies near Winnipeg were the Bossuyts, Van Welleghams, and Anseeuws, who arrived in Canada at the end of the 19th century.

In the 1920s, there were 127 producer-distributors in Manitoba, with 86 of these within the City of Winnipeg alone. The only inspections were for farms selling unpasteurized bottled milk and the pasteurizing plants themselves. When, in 1933, Dr. Ed Rigby began an inspection of dairy farms shipping milk, he found deplorable conditions, with inefficient cooling and no milk sheds. He found that milk pails, which were often washed in the kitchen, were often contaminated by someone in the home with an infectious disease. In 1936 the Municipal Health Department made a survey of these and cancelled the licenses of 46 shippers. Once they had improved their sanitary conditions they were allowed to ship their milk to city plants for pasteurization. That same year, vehicles conveying milk were required to be covered. This resulted from the fact that many of these distributors sold their milk unbottled. That meant it was dipped out of a container on the vehicle and poured into the homeowner's jug. Sixteen sellers operated in this way, while another 34 offered their customers a choice of dipped or bottled milk.⁶² Fortunately, the proportion of milk sold in this dipped form was relatively small. One can well imagine, in summer, the milk wagon proceeding down the street, surrounded by a horde of flies, stopping to dispense milk at each house. It was one of the reasons milk deliveries were carried out very early in the morning, before the heat of the day attracted insects.

Milked 10 Years Continuously by the B.L.K. Cow Milker

The Milker that was demonstrated and made the wonderful showing on the prize herd of Dairy Cows from the Insane Asylum Farm, Selkirk, at the recent Manitoba Dairy Convention.

*B.L.K.
Milkers
Imitate the
Calf's
Sucking*

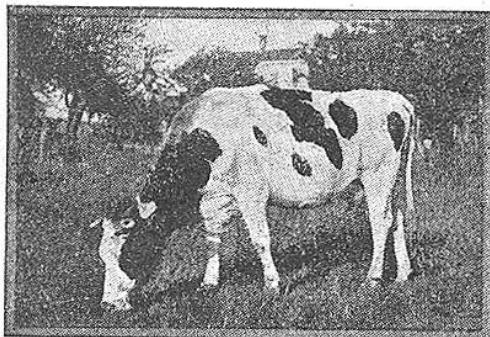

*More
Natural
Action than
the Human
Hand*

Milking for profit is solely a question of saving time—labor—wages—sanitary milk—large yields—getting all the milk. One-man operating two double unit Burrell-Lawrence-Kennedy Milkers is doing the work of three average hand milkers for several B.L.K. owners under average conditions. Hand milking a herd of say, 24 cows usually shows very little profit. With a B.L.K. Milker outfit the owner can put his hired help to other purposes—handle the Milker himself or let the boy operate it—save the yearly wage of several hand milkers—preserve the milk-giving ability of each cow—maintain the maximum yearly yield.

Exclusive Features—B.L.K. Single Tube Milker

Automatic Controller.—Regulates the vacuum in teat cup—perfect release with each suck—sufficient vacuum only to milk the individual cow quickly and thoroughly dry.

Universal Teat Cups.—Made of solid nickel silver—one size teat cup for practically all cows—no rubber linings—easy to keep clean—cheap to maintain. (Note:—D. H. Burrell & Co., have discarded the many types of teat cups and connectors used on other present day machines.)

Suction Trap.—Positively prevents any contamination from stanchion, hose and pipes from getting into the milk pail. Insures clean milk of low bacterial count.

Partition Pail.—Keeps milk from each cow separate, for records. No need for single machines—saves miles of trips to empty and twice as many pails and pulsators to wash and maintain.

Illustrated catalogue and History of Milking Machines free on request.

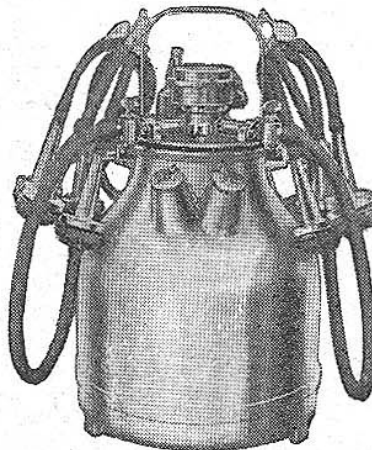

Tell us the number of cows you milk. We will send recommendation sheet Showing the size outfit you require.

ALBERTA DAIRY SUPPLIES LTD.

"EVERYTHING BUT THE COW"

Complete line of Machinery and Supplies for Farm Dairies, Creameries, Cheese Factories, Milk and Ice Cream Plants.

9925 101a Ave

::

EDMONTON, ALTA.

An early milking machine

Source: *Farmers Advocate & Home Journal*, 2 April 1919, p.572

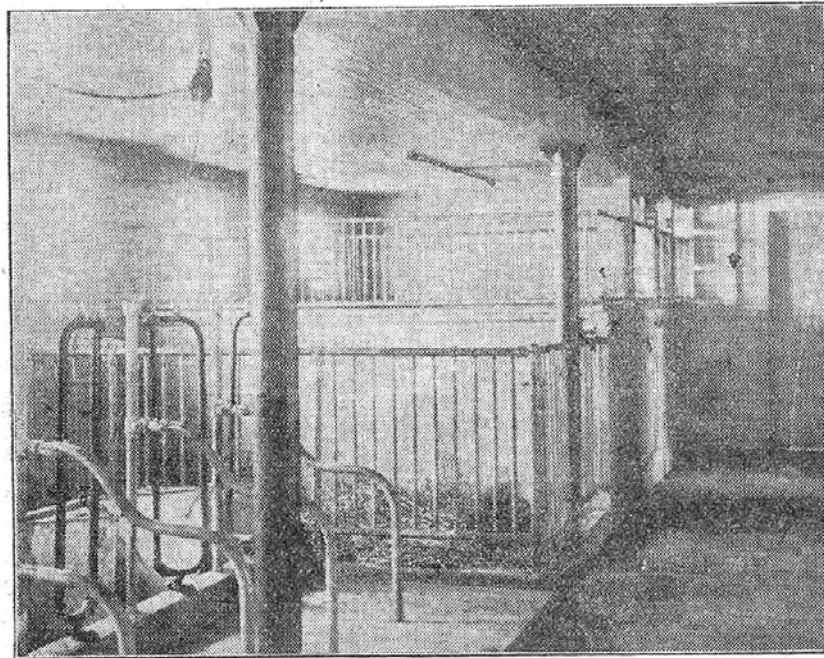

A corner of a modernly equipped dairy barn showing steel stalls for the cows and sanitary steel calf boxes.

Source: *Nor'-West Farmer*, 5 March 1919, p.312

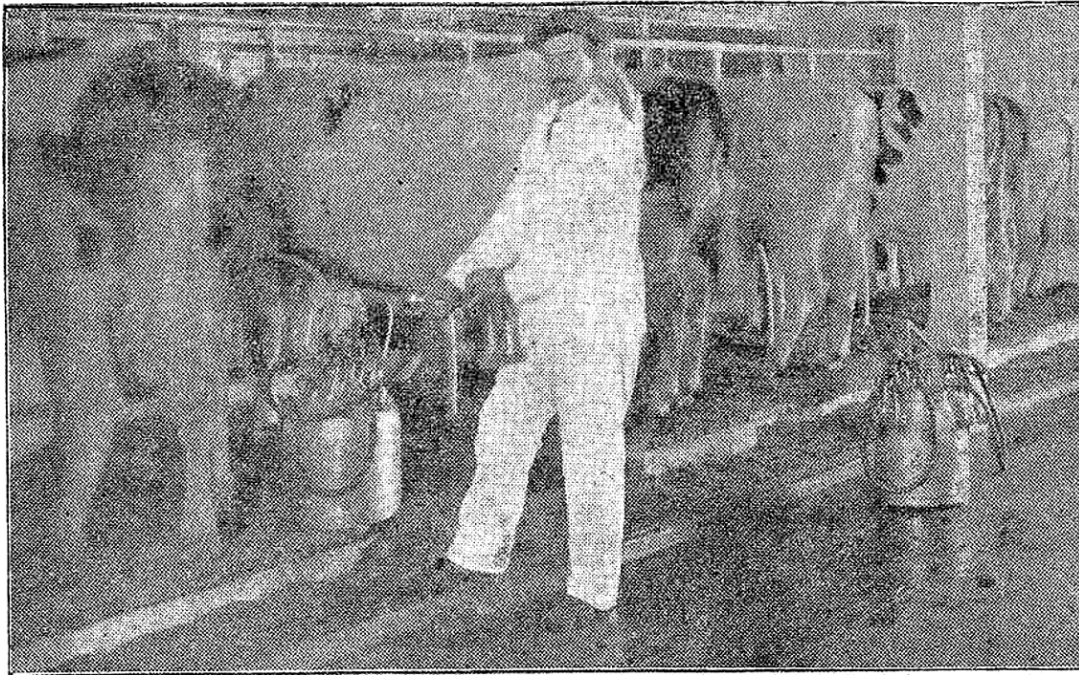

B. L. K. milker, as demonstrated at the Winnipeg Dairy Show. The cows are from the Holstein herd of the Hospital for the Insane at Selkirk, Man.

Source: *Grain Growers Guide*, 21 April 1915, p.9

Washing bottles and preparing the milk for delivery was a laborious job and often carried out by the women in the household. One lady recalled washing as many as 230 bottles for the next day's delivery. A sterilizing agent called Diversol was used. An eight-gallon (36 litre) can held the milk and the bottle was filled by the turn of a tap on the can. The milk was loaded onto a team-drawn sleigh in winter and wagon in summer. The milk cans of the earlier era would sway and slosh and sometimes, if the road was really poor, the shift in the load would cause an upset.

The Depression, while it brought a decrease in family income, was not accompanied by a decrease in the price of milk. Milk still brought farmers a good price, encouraging those farmers with milk cows to enter the bulk milk market. This led to over production and, since the big creameries would not cut their price spread, a 60% reduction in the price paid to the producer in 1932.⁶³ To avoid this, many more producers entered the door-to-door market. At the same time the demand for pasteurized milk was growing. This meant that any creamery willing to install a pasteurization plant was at an advantage.

Once pasteurized milk became the accepted product for consumers, dairy farms began shipping their raw milk to city dairies for pasteurization. The sale of pasteurized milk within the city was controlled in the 1920s by two major creameries: Crescent Creamery and City Dairy. Because they controlled the market, the two companies were able to control the price of milk. They maintained a highly profitable margin between their sale price and the price paid to producers. By 1931, this situation had drastically changed. First there had been mergers of various creameries, especially by eastern firms. In 1927, Eastern (Dominion) Dairies purchased Crescent Creamery, while its rival, Dairy Corporation of Canada, with headquarters in Toronto, purchased City Dairy in 1929.⁶⁴ New local competition had also evolved in Winnipeg: St. Boniface Creamery, St. Andrew's Dairy, and Modern Dairies.

Equally important was the arrival of chain stores in Western Canada. Until then, people did not purchase milk in stores, because lack of refrigeration meant that milk must come directly from the supplier early in the morning. Now stores like Piggly Wiggly, and its rival, Safeway, began selling milk as a loss leader in their stores. To compete, independent grocers banded together for larger purchasing power, forming the Associated Retail Grocery. Piggly Wiggly went one step further, bypassing the creameries to supply its own milk by purchasing Sundale Creamery, which would supply the dairy requirements of its Winnipeg stores.⁶⁵

A new player also entered the market. The Workers and Farmers Cooperative Association (WFCA) was organized in 1928 by people living in the North End of Winnipeg as a way of collectively purchasing fuel (wood and coal) at better prices. In 1931, the Co-operative answered a request by small dairymen beyond city limits to receive a better price for their milk, and to supply milk to the workers in the city. The peddler/producer was in direct competition with "those companies that exploit customers."⁶⁶ The WFCA was willing to go into such a venture "to demonstrate that working people and poor farmers could get together and challenge the way things were done in a capitalist society."⁶⁷ The Co-op served both the producers and the consumers and had to work out an arrangement that benefitted both.



Which will you buy a "cream thief" or a "savings bank" Cream Separator

WITH A GREAT MANY machines or implements used on the farm it doesn't make much difference which of several makes you buy.

ONE MAY GIVE YOU A little better or longer service than another, but it's mostly a matter of individual preference and often it makes little difference which one you choose.

NOT SO WITH BUYING A cream separator, however.

THE MOST WASTEFUL MACHINE on the farm is a cheap, inferior or half worn-out cream separator.

THE MOST PROFITABLE machine on the farm is a De Laval Cream Separator.

A CREAM SEPARATOR IS USED twice a day, 730 times a year, and if it wastes a little cream every time you use it it's a "cream thief," and an expensive machine even if you got it as a gift.

BUT IF IT SKIMS CLEAN TO the one or two hundredths of one per cent., as thousands and thousands of tests with a Babcock Tester show the De Laval does, then it's a cream saver, and the most profitable machine or implement on the farm—a real "savings bank" for its fortunate owner.

AS TO HOW MUCH CLEANER the De Laval skims than any other separator, the best evidence of this is the well-known fact that all other makes were discarded by the creamerymen years ago, and that to-day 98% of the cream separators used in creameries the world over are exclusively De Laval's.

THEN THE DE LAVAL IS SO much better designed and so much more substantially built and runs at so much lower speed than other separators that its average life is from 15 to 20 years, as compared with an average life of from 2 to 5 years for other machines.

THERE ARE OTHER ADVANTAGES as well, such as easier turning, easier washing, less cost for repairs, and the better quality of De Laval cream, which, when considered in connection with its cleaner skimming and greater durability, make the De Laval the best as well as the most economical cream separator.

REMEMBER, THAT IF YOU want a De Laval right now there is no reason why you should let its first cost stand in the way, because it may be purchased on such liberal terms that it will actually pay for itself out of its own savings.

DE LAVAL DAIRY SUPPLY CO., LIMITED

LARGEST MANUFACTURERS OF DAIRY SUPPLIES IN CANADA. Sole distributors in Canada of the famous De Laval Cream Separators and Alpha Gas Engines. Manufacturers of Ideal Green Feed Silos. Catalogues of any of our lines mailed upon request.

MONTREAL PETERBORO WINNIPEG VANCOUVER

50,000 Branches and Local Agencies the World Over

Advertisement for De Laval cream separators. De Laval was one of the most prominent dairy supply firms and had a warehouse in the Exchange District of Winnipeg.

Source: *Grain Growers Guide*, 21 April, 1915, p.18

The Co-op executive convinced its 143 producers/shareholders that the only way to compete with Crescent and City dairies was to build a pasteurization plant. The members loaned their capital to the Co-op to finance the purchase and refitting of a building at Dufferin and MacGregor St. in Winnipeg. The farmers were promised a fair price for their milk and the customers were offered the processed milk at 10 cents less than from major dairies. A price war erupted, with the major creameries attempting to have the health authorities shut down milk producers without licenses selling to the smaller stores. The chain stores cut milk prices to below home delivery prices. The new dairies, such as St. Boniface, St. Joseph's, and the WFCA sold their milk to the independent grocers at competitive prices. By buying all the surplus milk its members could produce, but at a somewhat lower price, the WFCA was able to increase its customer and producer base until, by March 1932, it was the fourth or fifth largest creamery (close to St. Boniface) in Winnipeg, with 6% of the city's pasteurized milk sales.⁶⁸ But Piggly Wiggly, the American-based grocery chain, continued the price war until the government of Premier John Bracken prepared legislation to bring the price of milk under the control of the Municipal and Public Utility Board in late 1932. It set a two-step price increment between what farmers were paid for their milk and what consumers had to pay for the product.

In 1932, the chain food stores still only had 4% of total milk sales in the province. Farmers were encouraged to produce milk to sell to a distributor, rather than distributing it themselves. In 1938, there were nine regular milk distributors, with 75 producer-distributors who operated 65 trucks and 29 milk wagons. Sixty of these operated one wagon only, while the remaining 15 had two or more wagons. An average wagonload was 165 quarts (187 litres) per day.⁶⁹ Gradually, the number of producers-distributors, or peddlers, decreased as licenses were withdrawn, until by 1945, the number had dropped to 34, and by 1958, to one.

While the number of producer-distributors dropped, the competition in the milk processing field grew. Standard Dairies (owned by Associated Retail Groceries), Royal Dairy, and Central Dairies all established plants in Winnipeg between 1933-1939. Modern Dairies, led by J.W. Spiers, purchased St. Boniface Creamery and Standard Dairies in 1935-6 and later, Central Dairies. Two non-Manitoba firms invaded the market during World War II: Palm Dairies of Calgary and Silverwoods of London, Ontario. Safeway took over Piggly Wiggly's Sundale Dairy and transformed it into Lucerne Dairy, which supplied all its stores.⁷⁰

The coming of war in 1939 actually brought a downturn in the dairy market as overseas markets for cheese and butter fell under German domination. After the entry of America and Russia into the war in 1941, farmers were encouraged to produce as much agricultural produce, grain and dairy products, as possible, for the Allied cause. At the same time, rationing was introduced. It had a definite effect on the dairy business. Delivery routes were cut due to gasoline shortages. Even maintaining the tires for trucks or wagons was difficult, since rubber was in short supply. Sugar and cream rationing reduced ice-cream production. Butter and butterfat rationing curtailed the local supply, making it difficult to sell coffee or whipping cream, and even buttermilk. As well, young men were enlisting, cutting the labour force. Processing plants hired women to take their places. The People's Co-op even hired a female delivery person in 1943. Her presence did not go unnoticed. "One morning a man was just going out of his garage when I happened to come along with the milk. He started stuttering to me about what I was doing in his yard at 6:00 a.m. But after he had seen the bottle of milk in my hand his face sure changed colour when he found out that his milkman was a woman."⁷¹

The Milk Control Board introduced new regulations during the war that changed the dairy industry. First, in March 1942, it prohibited stores from returning unsold milk to the creameries, where they had always claimed a full refund. This prevented over-ordering, which was wasteful

at a time when products were rationed. To reduce gasoline costs, the MCB also allowed only one creamery delivery per store per day. This led to a connection between a store and one creamery. The Canadian Government strengthened the dairy industry during the war by establishing milk subsidies. Producers, beginning in September 1942, received a 35-55 cent per hundred weight (8-12 cents per kg) payment, intended to encourage production. The consumer price subsidy, announced in December 1942, kept milk prices at 10-11 cents per quart (9-10 cents per litre).⁷² This prevented inflation, while maintaining a healthy diet for a populace deprived of many other rationed goods. It had the effect of increasing the number of milk drinkers and the number of milk producers. For example, the People's Co-op sold approximately twice as much milk in 1946 as in 1939, with 10,000 quarts (11,363 litres) going to home delivery customers.⁷³

While the number of producer-distributors dropped, the number of producers did not. Consumption of commercially-produced milk doubled between 1941-1960, due, at first, to the subsidization program, and later, to the urbanization process occurring during those years. Another factor was the baby boom of the post-war years. The number of producers, and the production per cow grew substantially, from 7,613,810 pounds (3,460,822 kg) from 791 producers in 1941, to 14,454,833 pounds (6,570,378 kg) from 1281 producers in 1955. While the number of producers dropped to 980 in 1960, the amount of milk produced continued to rise.⁷⁴ The number of processing plants also fell in this period as consolidation took place. In 1943, there were ten plants in Winnipeg.⁷⁵

Home deliveries were bound to drop in the post-war years with the purchase of cars and refrigerators by more families. As long as the price difference between home delivery and store prices remained at one cent per quart, the trend was not that noticeable. With the removal of the consumer price subsidy in 1946, the price of milk rose, and the chain stores were able to pressure the MCB to increase the differential between home and store prices to two cents. In fact, in 1951, the Provincial Government agreed to allow the MCB to do away with the mandatory differential between store and home delivery prices. The recommendation, however, was that no one was to sell milk below production cost. Safeway, however, with its own processing plant, could disguise its production costs, and sell milk below the price of the other stores and home delivery services. In fact, Safeway's Lucerne milk product sales increased by 300% between 1946 and 1951.⁷⁶ Such competition was bound to reduce the home delivery market to a minimum.

The introduction of Mini-Marts to Winnipeg, in 1964, further increased the competition in the retail milk field. Their sale of three-quart jugs of milk required the competitor to install the new packaging equipment as well. Milk now became a loss leader in the fight for grocery sales, as new large grocery chains such as SuperValu, Food Barns and IGA built in suburban areas. This was exacerbated in 1981 by the creation of the Manitoba Milk Prices Review Board which did away with price controls in the consumer market. Further deregulation of the market occurred in 1989 when prices, charged by dairies to independent jobbers who resold the milk on home-delivery routes, were also removed. With this, the home delivery system all but disappeared, and along with it important dairy-processing companies such as Manco, People's Co-op, and Lakeland Dairies of Selkirk.⁷⁷ The last to operate was Royal Dairy, which was eventually sold to Beatrice Foods Ltd. In recent years Beatrice Foods has been acquired by an Italian company, Parmalat.

BULK MILK COLLECTION

During and immediately after World War II, the number of fluid milk shippers was increased to take care of the greater demand for milk. Land that grew cereal grain crops was converted into dairy farms that now produced bulk milk rather than milk for cheese plants, as in eastern Manitoba. When, in 1952, the price of beef cattle dropped substantially due to foot and mouth disease, the switch to dairy cattle was a way to use up surplus grain, for which prices had dropped. The price of milk also rose, making dairying an attractive alternative to other forms of agriculture.⁷⁸ For the next decade, as farmers struggled with the changing agriculture scene, mixed farming seemed the preferred way to go. In 1964, of Manitoba's 35,000 farmers, 20,000 were shipping cream.⁷⁹

The farmers themselves arranged the first bulk milk pick-ups. They formed co-operative associations to provide a trucking service for their members. In April 1946, milk shippers living in the eastern part of Rockwood Municipality formed a cooperative to ship their milk to Winnipeg. On the back haul, the truck would carry farm supplies. In December 1952, another co-operative was formed in the Victoria and Good Hope districts. The two co-ops merged in 1955. Cream shippers were not excluded from the co-operatives. Although their produce was still shipped in cans, their produce was delivered to creameries in the district.⁸⁰ While milk was picked up daily, cream shipments were picked up at farms in four-day intervals. Farmers generally shipped two to three cans of cream, each can weighing 100 pounds (45 kg). The can weighed 20 pounds (9 kg), the cream, 80 pounds (37 kg).⁸¹ The deliveryman had to pick the cans out of the water-filled troughs, in which the farmer was storing them to keep them cool. The trick was to do so without getting oneself soaking wet, especially in winter.

Rural electrification programs in the 1950s altered the dairy industry by creating the possibility of refrigerating milk on the farm, meaning that it could be held for a longer time at the point of production. As well, electrification gave people the option of storing dairy products, such as ice cream, in their homes. Previously, ice cream was a treat that was either prepared for that day's consumption, or the family visited an ice cream parlour.

By the 1960s, the dairy industry was facing tremendous changes brought about by changes in merchandising and consumers' buying habits. The bulk milk tanker, farm bulk cooler, supermarket competition, and the harsh realities of retail route delivery, all had a profound influence on changing the dairy industry. The continual rise in labour, material, and equipment costs was reflected in the abandonment of milk cans for bulk farm tanks and pick-up. The bulk pick-up system lowered transportation costs and required less labour.

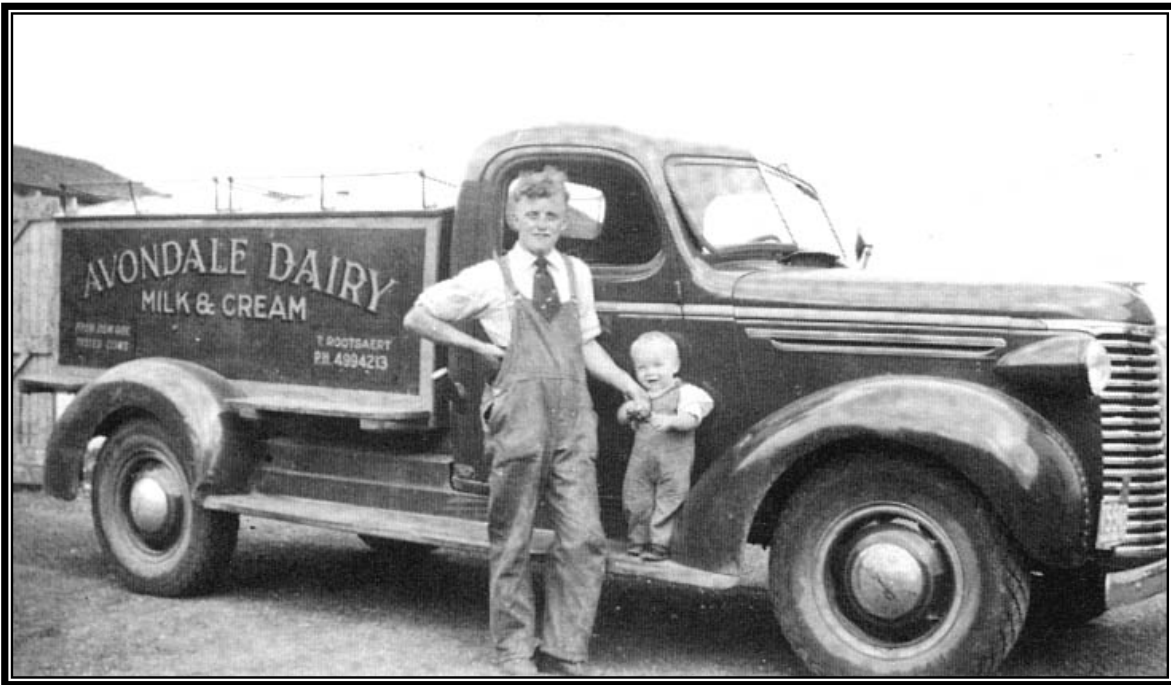

Avondale Dairy truck, 1940

Source: Rosser Centennial History Book Committee, *RM of Rosser - The First Hundred Years*, p.157



New milk truck, 1989

Source: Rosser Centennial History Book Committee, *RM of Rosser - The First Hundred Years*, p.157

The opening of every new shopping centre or supermarket affected the wholesale, retail, and home-to-home dairy and ice cream companies serving that area. If the supermarket was a wholesale milk customer, the wholesaler benefited from the increased volume marketed by the store. More often, the supermarket chains established their own dairy-processing plants, especially producing ice cream brands which they would then sell to smaller food stores. The presence of supermarkets cut the number of home delivery customers and forced the delivery companies to offer a larger range of products than just milk, since customers began to prefer the one-stop shopping experience.

It was obvious that bulk milk collection was the way of the future and some milk-processing plants, such as the Modern Dairies plant built in St. Claude in 1967, offered a loan to install bulk tanks so dairy farmers could get on board. The needs of the new manufacturing milk plant meant that they needed to double their number of suppliers. The company offered its customers CP Milk keepers obtained from an Ontario company at a cost of \$775 for a 100-gallon (450 litre) tank, \$1410 for a 300-gallon (1350 litre) tank, and \$1695 for a 400-gallon (1800 litre) tank, delivered and installed. It was estimated that a milk shed and cooling tank would cost the farmer \$3000 but it would pay for itself in the future, if only because the farmer and his family never had to worry about operating and washing the cream separator again! The price paid for farm-separated cream was 64 cents per pound (29 cents per kg) while the price, if shipped in bulk, would be \$1.00 per pound (45 cents per kg).⁸²

In 1966, there were 15,803 cream shippers, 716 manufacturing milk shippers and 662 fluid milk shippers.⁸³ In 1969 the federal Government set up a task force on agriculture. It recommended that the Canadian Dairy Commission try to adjust dairy producers to a time when there would be no subsidies, and to influence unprofitable dairymen to direct their energies into other types of farming. By 1977, this policy led to a reduction of cream shippers to 3864, industrial milk producers to 248 and fluid milk shippers to 1520. The total number of farmers producing dairy products had thus significantly dropped from 17,181 to 5,632.⁸⁴

In 1969, conversion to bulk milk collection was well underway. The number of milk producers by this time was on the decline, having dropped to 16,700 producers. Of these, 1,109 had installed farm bulk tanks. The size of these holding tanks ranged from 100 gallons (450 litres) to 850 gallons (3825 litres), with the majority at the high end. Of these, 654 were used for fluid milk and 455 for industrial milk. There were 45 bulk milk transports in the province. Licensed milk graders, who had completed a bulk milk receiver's course, as prescribed by the Animal Industry Branch, operated these transports.⁸⁵ At that time, there were still 15 dairies and five industrial milk plants in the province.

In this period, agricultural specialists were encouraging farmers to enter the dairy field. A newspaper article stated:

One of the most attractive livestock enterprises at the present time is the milk shipping business and the forecast over the next few years indicates this situation will continue to exist. Over the next five years another thirty million pounds (1,363,636 kg) of milk from the Interlake could find a market. There is room for at least eighty new producers.⁸⁶

The appeal must have been fairly successful because one year later the industry was in crisis, due to overproduction.

In 1975, there were 1,780 farmers shipping milk in bulk. There were 81 tankers hauling milk to 14 fluid milk plants and nine industrial milk plants.⁸⁷ The smaller milk plants had been driven out of the market by the high costs of converting to the new packaging equipment and the necessity of maintaining a high level of quality control, which required highly qualified staff. As improved roads cut transportation times, shipping milk in bulk showed many advantages. Dairy farmers installed pipelines to carry their milk from the milking machines to the cooling tanks (270 pipelines existed in 1975), and this investment actually saved them money in the long run.⁸⁸

Fluid milk requires different processing than previously, when the cream was separated on the farm. Today the dairy farmer stores the milk in cooling tanks at a temperature no higher than 10 degrees C. At the plant, the milk is clarified by high powered centrifuge and the cream is separated by high powered centrifuge as well. The milk is pasteurized by being heated rapidly to a temperature of 72 degrees C for 16 seconds, or up to 85 degrees C for no holding time. The milk is next homogenized by being forced through very small holes in order to break up fat globules, resulting in a consistent liquid. The milk is then stored at a temperature of 1 degree C to 7 degrees C, with a storage life of 15-30 days.⁸⁹ The dairies then distribute the milk to the manufacturing and retail firms requiring it.

REGIONS OF DAIRYING

The areas that can support dairy farming are dictated by the needs of lactating cattle. Although much of the knowledge of the nutritional needs of these cattle has been accumulated over more recent decades, basic knowledge of how to sustain a dairy herd has existed among dairymen for centuries. In order to produce at maximum capacity, a dairy cow must have large amounts of water, anywhere from 100-300 pounds (36-45 kg) per day, depending on her size, the moisture content of her feed, the temperature and humidity. For each gallon of milk a cow produces, 400-500 gallons (1800-2250 litres) of blood must pass through her udder. To produce 10 gallons (45 litres) (80 pounds or 36 kg) of milk daily, 15-20 tons (13,636 - 18,182 kg) of blood must course through the udder every 24 hours. This 10 gallons (45 litres) of milk contains 3 pounds (6.6 kg) butterfat, 3 pounds (6.6 kg) protein, 4 pounds (8.8 kg) lactose and 1/2 pound (1 kg) mineral, all of which must be supplied by her water and feed intake.

Today, most dairy cattle are fed a supplementary diet of dried rations that contain the mineral and protein contents needed to help a cow produce at maximum quality and quantity. In the historic period, all this nutrition had to come from pasture and hay. A 1400-pound (636.36 kg) cow requires 100-200 pounds (220-440 kg) of pasture per day or 5-6 tons (4545-5454 kg) of hay annually. This has to be supplemented by grain, especially during the winter months when the pasture is covered in snow. It takes two pounds (.9 kg) of grain to replace three pounds (2.7 kg) of hay. In the mid-20th century, Manitoba farmers began to produce silage crops with which to replace hay and grain feeds. Silage has a high moisture content and it takes 2.5 - 4.5 pounds (1-2 kg) of it to equal one pound (1 kg) of hay. But corn silage, for example, is higher in nutrition than the hay it replaces.⁹⁰

Feeding grain to cattle is very expensive and the amount of grain it will pay to feed milking cows depends upon several factors: quality and price of forage, price of milk, and the producing ability of the cow. Since lower grades of grain were always available for feed in Manitoba, generally farmers fed their dairy cattle grain supplements, especially during the winter. But only where soils were marginal and did not produce wheat, which sold at high prices in the settlement period, would farmers have used the land to produce the oats and barley that would be fed to cattle.

In some areas of Manitoba, hay grows abundantly in the wild but this hay does not always possess the nutritional value to sustain a lactating cow. George Morton, of Boissevain, tried to establish a dairy around Whitewater Lake in 1881, but his entire herd perished during its first winter because the native hay did not provide enough nourishment. Hay lands found around lakes, such as those of Lake Manitoba, have traditionally been used for raising beef cattle, rather than dairy herds. Although the lake lands also contained the water supplies needed for dairy cattle, it was not here that dairying developed. Instead, uneven lands, where gullies filled with rain and drainage water, became popular for dairying. These included the Pembina Hills, Brandon Hills, eastern Manitoba, and the Interlake, all of which became popular dairy regions.

Beginning in 1947, the prices of coarse grains such as oats and barley, and beef cattle, rose by 50%. Many large dairy farms near Winnipeg decided to switch to grain or beef cattle production. Small farms remained in the dairy business because they did not have such large land holdings. It was at this time that the Winnipeg milk shed was extended further into southeastern Manitoba. The farmers there had previously produced milk for cheese production. In 1950, due to the existence of hoof and mouth disease in Canada, cattle prices dropped by 30%, causing another upsurge in dairy production. The raising of the price of milk also made dairying more attractive.⁹¹ Dairy farms in Manitoba grew to number 25,562 in 1961, and declined to 4,302 in the next 15 years.⁹²

*In identifying the families that operated dairy farms in all the regions of Manitoba, only the name of the husband has been mentioned. This is in no way intended to convey the idea that the wives were not important partners in the operation. Spouses' names were omitted purely in the interests of containing the length of this document.

CENTRAL MANITOBA

The geographic region known as the Pembina Hills, stretching from Roseisle in the east to Glenboro in the west, and including the communities of Notre Dame de Lourdes, St. Alphonse, Cypress River, Bruxelles, Swan Lake, Somerset, Baldur, and Holland, was originally settled by French-speaking families from France and Belgium at the end of the Nineteenth Century. Here, human geography has combined with physical geography to create one of the dominant dairying regions of the province. Many of the pioneers, because there was no market for milk, other than a few pioneer cheese factories, for many decades concentrated on shipping cream. The creation of bulk milk collection has been a boon to the region and a stimulant to the dairy traditions of the inhabitants. Today there are 53 farms in the Pembina Hills with bulk-milk contracts.⁹³ Almost all of these are operated by families with French or Belgian roots.

In the Cypress River-St. Alphonse area, several families have been dairy people for more than three generations. Firman Wytinck and his wife settled on 9-6-12W in 1942. Of their six children, three have continued the dairy tradition. Daughter Marjorie married Rene Ricard of Baldur and their son Randy now has a bulk milk contract. Son Lawrence has run a dairy operation on SW2-6-13 since 1969. Son George has their dairy farm on NE8-6-12W. A cousin, Marcel Wytinck, lived on 17-6-12W and had a bulk milk contract until 1975.⁹⁴ The De Smet family began keeping dairy cattle in 1918 when Octave De Smet purchased N8-16-12W. His son Maurice, and now his grandson Edward, have carried on the dairying operation.⁹⁵ Jules De Baets came to St. Alphonse in 1928, raising a dairy herd on NW10-6-12. He has been followed in the business by his son Maurice and his grandson Bryan.⁹⁶ Maurice De Lichte has had a dairy operation on SE34-5-12W since 1960. Most of these families have a mixed dairy and grain-farming operation.

Pierre Bosc came from France to the Notre Dame district, homesteading SE30-7-8W, in 1893. Four generations of Boscs: Pierre, Augustin, Remi and Marcién, and now Normand and Guy, have maintained the family dairy farm in the area. Since the 1930s their herds have been Holstein.⁹⁷ Pierre Bosc's daughter, Ernestine, married Isadore Simon, the son of another French immigrant to the district, Francois Simon. Their descendants still have a bulk milk operation on the family farm, SW30-7-8W.⁹⁸

In the Somerset area, there were several dairy farmers who distributed their milk to residents of the village. These included Louis Laporte (1913-), Phedime and Maurice Gregoire (1928-), George Arnould (1901-1907), Wilfrid Potvin, Leon De Ryck (1939-1951), Laurent Jubinville (1938-1952), Joseph Lesage, and Harold Clark (1956-1980). Many more farmers shipped their cream to the Somerset Creamery, which offered pick-up in a wide territory.⁹⁹

In the Mennonite settlements in the West Reserve, farmers always produced dairy products for their own use but they lacked the close urban market enjoyed by their co-religionists in the East Reserve. The Depression and the drought that accompanied it, caused the Mennonite farmers in the area to increase the number of their cows from three to ten, in order to create an alternate source of income. In Rhineland municipality around Altona, the number of milk cows increased from 3,896 in 1931 to 5,593 in 1941.¹⁰⁰ This attempt by the local farmers to diversify their operations led to a surplus of milk, and an accompanying decrease in milk prices. This, in turn, led to the creation of the Reinland Co-operative Dairy Society in 1936. This organization created the Reinland Cheese Factory, which operated from 1937 to 1949, drawing milk from six surrounding villages.

Galloway's Sanitary Separator

2,000 of these New Galloway Sanitary Perfect Skimming Cream Separators at special anniversary sale prices. They are made so good in our own factories that I will send one anywhere without an expert to set it up, to any inexperienced user for a 90-day trial, to test against any make or kind that even sells for twice as much and let the user be the judge. It's the most modern, the most sanitary, the most scientific, the cleanest skimmer, the most beautiful in design of any cream separator made today and I have seen them all. Positively sweeping the field before it.

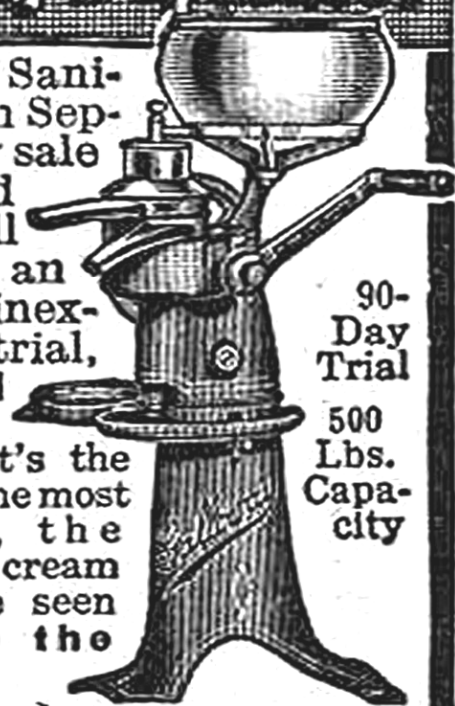

90-
Day
Trial
500
Lbs.
Capa-
city

Advertisement for another brand of cream separator
Source: *Grain Growers Guide*, 21 April 1916, p.28

The Winkler Co-operative Creamery was established in 1939. Cream could be shipped to the Morden Creamery as well. In the area south of Winkler, dairy herds were improved, with a herd-improvement plan sponsored by the Co-operative in 1947, and the establishment of calf clubs for young people.¹⁰¹ Once grain prices rose, and diversified crops, such as sunflowers and sugar beets, were introduced, many farmers lost interest in dairying. This was inevitable, since the land in the region was far too fertile to be used as pasture, or to grow forage crops. Four major dairy farmers remained into the 1980s: Jacob Wieler, Bernie Elias, Bernie Zacharias, and Ens Farms Ltd, who all shipped their milk to the Winkler Creamery. In January 1976, Ens Farms shipped 79,129 pounds (174083.8 kg) of milk to Winkler, a huge increase from its production of 3,763 pounds (8279 kg) in January 1946.¹⁰² A few families in the region, including the Elias, still have bulk milk quotas.

In Gnadenfeld, many farmers raised Holstein cattle, the largest herd of about 50, belonging to the David Wiebe family. Gnadenfeld resident, Cornelius Peters, needing cash during the Depression, decided to find a market for his excess cream. He loaded four three-gallon (13.5 litres) cans of cream into his buggy and set out for Winkler Creamery. The manager made an agreement with Peters that he could start a cream delivery route in his district. Thus began a twelve-year career for Peters as the "Schmaunfeara." Every Thursday morning at 6:00A.M., Peters started at the east end of town, sounding his shrill whistle, which caused all kinds of cream containers to be brought out. Soon his business was booming and he had to buy a larger wagon, with the capacity to hold 15-20 cans. Other villages, such as Friedenruh and Reinfeld were added to his route. Finally, the creamery manager bought Peters a truck, which further increased the business.

Peters was responsible for washing all the cream cans at the creamery before returning them to their owners, along with their cream money. He not only collected cream cans, but also requests for errands, six days a week. His customers, unable to travel to the larger market centre, regularly requested that he purchase such items as bridal lace, while he was in Winkler. The strangest request a cream deliveryman probably ever had to handle occurred the day an older gentlemen, a widower, asked to accompany Peters. Along the way he informed Peters that he was going to look for a wife, saying, "When we come to a certain house in the next village where an eligible young woman lives, I would like you to go in and ask for her hand in marriage for me."¹⁰³ Although Peters declined the commission, when the truck reached the house the gentleman refused to budge from the truck. The poor creamery man had little option but to carry out the mission. Although the girl's parents were very excited about the proposal, their daughter refused the milkman and the prospective groom!

Because Macdonald municipality was close to Winnipeg, dairying became an integral part of the region. The first dairy farmers in the municipality were the Fabrics and Jantzens. The Jantzens came from Holland to 30-9-1E, near Oak Bluff, in 1905-6. They hauled their milk overland to Headingley where a train picked it up for delivery to Winnipeg. In 1910, their dairy farm was taken over by the Whettell family who hauled their milk to Oak Bluff station for shipping via CNR. The Whettells also offered home delivery.¹⁰⁴ In 1923, the Whettells moved back to Fort Garry, where they had originally had a dairy.¹⁰⁵ Their Oak Bluff farm was reactivated as a dairy farm in 1961 by the Vis family, who installed bulk milk tanks. They ceased operations in 1976.

The Bernard Stephenson family came from England in 1905 and built a dairy farm on 32-9-2E, hauling their milk to Winnipeg. In 1909, Robert Jefferson took over that dairy, delivering his milk door-to-door in Winnipeg. The milk was ladled from eight-gallon (36 litre) containers directly into customers' quarts. Jefferson found the Oak Bluff farm too distant from his customers in

Winnipeg and moved back to a Cambridge Street dairy in Winnipeg in 1910. The Oak Bluff dairy was sold to Charlie Muys, who sold it to Oscar Roeland in 1937. The Roelands were one of the ten original milk shippers to the Piggly Wiggly creamery, which became the Safeway Lucerne plant.¹⁰⁶ The family moved to St. Boniface in 1940.

From the early 1920s to the 1970s, the Anseeuw family ran a dairy in the area. The father, Hector, came from Belgium in 1912 and worked on other Belgian dairy farms in the Fort Garry area before establishing his own dairy on SW5-10-2E. The sons and their wives carried on the tradition. Another large operation was that of Howard Leslie who amassed a herd of 250 cattle on 2000 acres (810 hectares) between 1924 and 1957. The Ammeter family had a dairy herd near Starbuck in the 1930s, and still ships bulk milk. Two Fort Garry dairies re-established themselves at Oak Bluff, beyond city limits: the Bossuyts brothers in 1942 and Nestor De Meyers in 1961.

The area around La Salle still had five French families operating dairy farms in 1986: Claude and Donald Lagace, Roger Lavallee, Pierre Lanoie, Robert Gousseau, and Ovide Gousseau. Several of these were second-generation dairy farmers.¹⁰⁷ Henri and Alice Gousseau started the Gousseau dairy in 1929 on SW11-9-2E. In 1934, a disastrous fire destroyed their dairy barn, but the cows were led out before the roof collapsed. One son, Ovide, started his own dairy farm near his father's place, while a second son, Robert took over the family dairy. Robert modernized it in 1983. Both Henri and his son served terms on the board of the District Milk Producers' Association.¹⁰⁸ Roger Lavallee took over the dairy on 35-8-2E, started by his father, Elphege Lavallee, while his sister, Jeanette, married Ovide Gousseau. Generally, however, the land around this area was too fertile to be used for pasture and forage crops and the cattle were gradually displaced by grain production, a much less labour intensive occupation than dairying. Only two dairy farms remain in the Lasalle district, one being operated by the Lavalles.



An example of a large dairy barn in the 1930s - This one was equipped with a manure carrier
Source: Horndean Reunion Committee, *Horndean Heritage*, 1984, p.57

An important dairyman in the Morris area was Lawrence Breyfogle. The family came from Minnesota in 1924 to establish a grain farm on 32-6-2E. Economic conditions in the 1930s converted them into dairy farmers. From three cows, two heifers and a registered bull the family built a herd of 65 head of Holstein cattle. In 1939, one of the Breyfogle's cows was named the third highest producer of butterfat and milk in her class. Concerned with efficiency, the family installed gas-powered milking equipment after the war, and in 1950 switched to a bulk tank. Lawrence Breyfogle was also instrumental in introducing artificial insemination in Manitoba in the 1930s, and was director of the Holstein-Friesian Association for a number of years.¹⁰⁹ The family farm was sold in the 1970s.

Dairying in central Manitoba was stimulated by the decision, by Modern Dairies in 1967, to create a manufacturing milk plant in St. Claude. Contracts were offered to farmers within a 90-mile (144-km) radius of the plant and loans were offered to provide the capital investment needed to purchase bulk-cooling tanks on the farms. Farmers needed about \$3000 to build a milk shed and cooling tank, but this investment was offset by the higher price paid for butterfat in the form of whole milk, as opposed to the price of butterfat in separated cream.¹¹⁰

The purpose of the St. Claude plant was to prepare manufacturing milk - milk used in manufacturing other foods - which was reduced to a concentrated, dried form. In the St. Claude plant, heating, concentrating and drying were all completed in one unitized system.

The area from Elm Creek to Rathwell, with its wooded areas and water supplies, and proximity to the marsh areas of the Lasalle and Boyne rivers, was good cattle country. As early as 1890, a farmer in the Elm Creek area, J.W. Johnson, purchased "one of the finest Durham bulls in the country."¹¹¹ This would have improved the quality of the herds in the region. While many farmers in the area preferred to raise beef cattle, the French-speaking farmers had dairying backgrounds and the creation of the milk-processing plant in St. Claude was based not only on the village's proximity to Winnipeg, but also on the dairy traditions of the local farmers.

Even before World War II and the era of increased dairy production, at least 12 farmers in the RM of Grey had herds, mostly Holstein, on ROP. Damase Dequier, on SE3-9-7W, was a long time milk shipper. He had to haul 24 cans of milk three miles with horses in order to reach the milk truck, which came twice a week in winter. His son and grandson have continued the family dairy. Antoine Dequier also had a registered Holstein herd, on SW5-9-7W. Eugene Fay, Auguste Fay, and Louis Valiant all had dairy farms in the Haywood area. At Elm Creek, George and Raymond Jones had a Holstein herd on NE32-8-5W in the 1940s. At Rathwell, Jean Baptiste Vuignier had a ROP Holstein herd on SE21-7-8W.

Alexis Philippot started his dairy farm on NW7-8-7W in 1912. In the 1930s, he had fifty milk cows, milked by hand by his 11 children, until the wonderful day in 1944 when the Philippot family became the first farmers in the area to purchase a milking machine. It was a four-pail stainless steel unit powered by a gas engine. Philippot sold his cream but fed the skim milk to his calves and pigs. The hay for this herd was collected each summer with a bucking pole until 1945 when the first baler was purchased, making the haying season less labour intensive. A large stanchion type barn was built in 1930, and remained in use until 2001 when the third generation of Philippot dairy farmers replaced it. Alain Philippot purchased the farm from Raymond in 1991, and currently has 64 Holsteins.¹¹²

Today, there are 37 farms producing bulk milk in Grey Municipality, most of them carrying on the dairy tradition of their French and Belgian ancestors.¹¹³ The area spreading to the east, west, and south of St. Claude continues to be one of the major dairying regions of Manitoba.

North Norfolk municipality, in 1906, had 719 farms and 4000 cows. This averaged out to about five per family.¹¹⁴ Generally, farmers who shipped cream kept no more than six to ten cows because that is the number two people could milk efficiently morning and night. After the closing of the local creamery, the cream in this district was shipped to creameries in Portage la Prairie, Gladstone or Brandon. In the 1970s, most of the dairy farmers changed to fluid milk production.

The predominantly French farmers living in the RM of Montcalm all indulged in mixed farming but the presence of cheese factories at St. Joseph, Letellier, St. Elizabeth, Arnaud and St. Jean Baptiste encouraged them to ship milk there or cream to creameries at Dominion City, Morris and St. Boniface. Two farmers in the St. Joseph region who had large dairy herds were Adelard Fillion and Ernest Dionne. Fillion had a herd of Holsteins from 1940 to 1960 and also had a contract to supply milk to Modern Dairies. Dionne, who began dairying in 1914, had 35 milk cows, shipping the milk to the cheese plant in St. Joseph. He also had two milk routes along which he collected milk for the factory.¹¹⁵ Today, there are only three dairy farms remaining in the municipality, but the museum at St. Joseph contains many artifacts that reflect the dairy traditions of the area's past.¹¹⁶

There were three large dairy herds in the Morden area in the early 1900s. The Ramptons and Doerns delivered their milk door-to-door. Henry Lauman had a prize-winning Jersey herd in 1910, and may have sold his milk to Ramptons. The creamery in Morden was established in 1912, and Lauman could certainly have shipped his cream-rich milk there.¹¹⁷

The creation of two airbases in the Portage la Prairie (Macdonald and Southport) region at the beginning of World War II created a demand for milk. Many farmers in the surrounding region had been milking a few cows by hand and shipping the cream to Portage or Gladstone creameries. In 1940, the Portage la Prairie Creamery pressured the farmers to ship bulk milk instead, and even provided a truck and driver to pick up the milk. In the Westbourne area, the Davey, Robertson, Beven, and Black families signed contracts with the creamery to produce milk.¹¹⁸ Soon the farmers found themselves responsible for delivering the milk to the plant. In 1967, bulk milk delivery came into effect, and modernized equipment made the product safer, as well as cutting the labour.



Leslie dairy farm near La Salle, c.1960

Source: Betty Dyck, *Hugging the Meridian – Macdonald: A Manitoba Municipal History*. p.176

INTERLAKE

In 1899, William Van Horne, builder of the Canadian Pacific Railway, chose to build a large farm on the east side of the Red River at what became known as East Selkirk. The farm was to exemplify the great agricultural potential of the Canadian West and thus to encourage settlers to take up land along the CPR. Part of this operation was a dairy farm, stocked with several carloads of Dutch Belted cattle shipped from Van Horne's farm at St. Andrews, N.B. in 1903. After Van Horne's death in 1915, the farm limped along under various managers for the Van Horne estate until 1936 when the Searle Grain Co, a family owned company out of Minneapolis purchased it. By then, the cattle were mostly shorthorns. In the 1940s, a Holstein herd was added under the Searles. A new barn, with modern milking parlour, milk line and cooler tank, replaced the old barn. Continuous progress converted the dairy into one of the largest in the province in the 1950s. In 1964, Searle Grain sold 900 registered cattle, the largest dispersal sale ever, at Lake Francis where the farm had been expanded to take advantage of the pastureland in the region.¹¹⁹ The dairy herd was kept until 1971, when the farm was broken up and sold. During the 1966 March snow storm, the dairy staff at the Searle farm had faced a major dilemma - how to milk 90 cows without any electric power. The experienced staff solved the problem by rigging the grain auger engine to drive the vacuum pump, thus enabling the milking machines to be used.¹²⁰

The area directly north of Winnipeg, parts of which are now within the City of Winnipeg, could have been a prime dairying area, because the soils and natural vegetation made it ideal for cattle. The river lot system, however, was a deterrent to keeping large dairy herds because the lots were small and pasture scarce. The narrow plots were better utilized as market gardens, producing the vegetables needed as much as dairy products by city dwellers.

The Ted Partridge family established Devan Farm in 1922, in the area known as Cloverdale and delivered milk to Selkirk townspeople for years. The David Small family established another dairy farm on 13-14-3E in 1943. The dairy part of the farm was sold to A. Rohm in the 1970s.¹²¹

W.D. Aime started a Jersey dairy in 1920 at Clandeboye. This herd was built from two registered Jerseys brought from North Dakota in 1912, and a registered bull purchased from the Baskerville farm in Dominion City in 1914. The Aimes shipped cream to the Manitoba Cooperative from 1920-1930, when low prices convinced the family to take the Hazelglen Jersey farm into the delivery business. A milk house was built on the farm in 1931, and Hazelglen products, from milk, cream, eggs and honey were delivered to Selkirk stores. This delivery continued until 1962 when a third generation of Aimes went into the bulk milk business. After 1972, one of the sons registered the herd under the name of Elm Glen Jerseys and continued in the dairy business until 1980.¹²²

Another dairy farm in the Clandeboye area¹²³ was started with two cows by Joe Kamer, an emigrant from Switzerland, in 1938. By 1943, the Kamers were shipping milk to Crescent Creamery. The dairy farm continued until 1980. William King ran a dairy farm at Clandeboye from around 1900 to 1918, shipping his milk by train to Winnipeg. He let his cattle run loose, since there was yet no municipal herd law. The family milked forty cows by hand.¹²⁴



This young lady is milking a cow of mixed breeding, but the milk was still sufficient for the family's needs, and to fill a cream can for shipping once a week.
Source: PAM, Poplarfield Collection, photo FL-224

The Hugh McPherson family settled on NW10-17-4E at Matlock, near Lake Winnipeg in 1926, and established a dairy business, selling milk and cream to summer residents and shipping cream and butter the rest of the year. In 1942, they discontinued the seasonal business when they acquired a contract for shipping fluid milk. A modern barn, with a De Laval milking machine, greatly improved the operation. The dairy farm was sold to Howard Dremrey in 1954.¹²⁵

The RM of Rosser, located very close to Winnipeg, had many dairy farmers, some of whom delivered their milk directly to customers, and others who took it to large city processing plants. The long hours that it took to bottle the milk caused some dairymen to choose the latter over the former. As regulations for bottling and shipment of milk became stricter after World War II, many abandoned their milk delivery routes and shipped their milk to Winnipeg dairies. Small dairymen left the business in the 1960s, but three dairy farms still exist in the region: Georgison Farms on SW33-12-2E, Grenkow Farms on SW2-12-2E and Allan Grenkow on NE3-12-2E.

In the Gross Isle area, many farmers were fluid milk shippers, using the railway to ship eight-gallon (30 litre) cans of milk to City Dairies under contract. Included in the families undertaking this economic activity were the Corbett, Murray, Hagerman, Lindley, Craig, Davidson, Beachell, Lamb, Borthistle, Madill, Palmer, Klein, Laplan, Carter and Pressman farms. The Pressman family had an added sideline. Aided by the Canadian Jewish Congress, the Pressmans, and seven other Jewish families, settled in the region in 1934. They used their connections in the Winnipeg Jewish community to market cottage cheese, sour cream, and sweet cream directly to city customers. The Pressmans were the last remaining Jewish farmers in the Gross Isle district. In 1958, they changed their dairy farm to a beef cattle operation which was sold in 1988.¹²⁶ Today, there are no dairy farms in the Gross Isle region.

In the Stony Mountain area, the Vandekerckhove family established a dairy farm in the 1920s. The Belgian family had originally settled at Swan Lake.¹²⁷

Sam Sims, who became the head of the Holstein-Friesian Association of Canada in 1930 and 1938, had his dairy farm, East View, in the Argyle district. His large barn was a landmark in the district until destroyed by a tornado in 1984. Sims sold his purebred herd in 1919, but as a leading member of the national association, continued to work to promote the breed.¹²⁸

The more interior area of the Interlake had natural advantages for dairymen. There was an abundance of water and natural hay fields. The area around Shoal Lake was a particularly popular place for the farmers to collect hay. During haying season, the men would leave their wives in charge of the cattle and take haying equipment to the area for a week at a time. Farmers also were allowed to pasture their cattle along road allowances and the natural hay fields all summer. Once the cows were milked they were released to forage for themselves. Their distinctive bell would allow the farmer's family to find their herd and return them to the barn for evening milking. When the areas became more populated in the 1940s, and the areas around the lakes was occupied, herd laws were passed by the municipalities to end the practice of free ranging cattle.¹²⁹ Further north, in the Poplarfield district, most mixed farmers produced cream to sell at the local creameries located at Chatfield and Fisher Branch. The Stawychny family chose dairy farming in the 1940s, when most of the area's farmers switched to beef production.¹³⁰

Farmers in the Geysir District, such as Svanberg Sigfusson, were induced to keep dairy cattle after the opening of the Arborg Creamery in 1920. Once adequate drainage systems were constructed in the Icelandic River watershed in the 1960s, the Geysir-Arborg region's abundant

hay fields were protected from flooding. Farmers could either raise dairy or beef cattle. Carl and Mary Johanson established a dairy herd in 1950. In 1964, with the new quota legislation, they made the decision to spend the money to go into bulk milk production. They bought a larger farm on NW16-22-3E, increased the size of their dairy herd, built a modern free-stall barn, and became one of the largest milk producers in the district.¹³¹ Today, there are nine bulk milk producers in the district.

The Lake Francis area north of Woodlands was a natural hay meadow long before settlers arrived. In fact, the tall grass was the site of constant range fires. One, the Bonnie Doon fire of October 2, 1897, took several lives and consumed many pioneer farms. Once transportation facilities were in place for shipping cream and milk to Winnipeg, however, the area lent itself well to dairying. Many families were already operating successful dairy operations before the quota system was put in place and were able to expand their operations. The Wilfred Brad family began farming in the area in 1920, and by 1965 they had a herd of 40 milk cows.¹³² A descendant carries on the dairy tradition. Franz Hueging came from Germany in 1952, and established a dairy farm in 1954 with eleven cows. Today, three family members hold milk contracts in the Woodlands area.¹³³ Dave Laramée owned a dairy farm in the area in the 1940s, shipping milk for twelve years. When the quota system came into being, the Laramées switched to shipping cream before selling the farm.¹³⁴ This farm may be the one purchased by Henry Moellenbeck from Germany in 1959. With a bulk milk contract, the farm remained in family hands into the 1980s.

The Naaykens family came from Holland in 1924 and purchased a dairy farm from Fred Sherwood in 1940 in the Lake Francis district. The Naaykens later went into the transfer business, hauling milk. Jonathon and Edward Park started a dairy farm in 1921, shipping the milk daily by railway, alternately from Raeburn and Lake Francis stations. The lack of decent roads in the region made this a particular hardship. Later Allen Green ran a transfer, picking up the milk for delivery to Winnipeg. Allan Green also had a dairy farm, which he sold to Emil Olson in 1955. His son, Lloyd, took over the farm and became a director of the Manitoba Holstein Dairy Club.¹³⁵ Jim Riding began shipping fluid milk in 1955 and ran a dairy farm until 1983 when the family switched to Limousine beef cattle. Another German immigrant, Gerhard Uppang, settled in the Bonnie Doon area in 1957 and soon had 18 Holstein milking cows and a quota to ship milk. Although the family went into grain farming in 1980, they have kept their milk quota.¹³⁶ Alex Lloyd established a dairy farm in Bonnie Doon in 1950, and sold the farm to Frank Wiens' family in 1955. The farm and quota are still in the family.¹³⁷

In 1954, the two Koene brothers from Holland bought 1600 acres (640 hectares) in Township 15, Range 1W, northeast of Woodlands, and started the A-Bar Ranch. The land was unsuited for grain growing, but the Koenes ran a herd of 122 Holstein dairy cattle on it.¹³⁸ They built a large modern barn to house 60 cattle at a time. The firm trucked an average of 25, 80-pound (36-kg) cans of milk to Winnipeg daily.¹³⁹ This enterprise appeared to last only about a decade. Another dairy farm, owned by Jim Keen in the Ossawa district (Township 14 Range 4W) in the late nineteen seventies, may be related to this operation.¹⁴⁰

The district around Marquette, located between the Assiniboine River and Lake Manitoba, and around Long Lake, also contained meadowlands suitable for raising cattle. While most of the pioneers engaged in a mixed-farming economy, many recognized the potential for dairy farming provided by the area's proximity to Winnipeg, located 35 miles away. William Taylor started a dairy farm on SW29-13-3W in 1907 with a herd of Holsteins. He shipped his milk daily. So devoted to his profession was he that "one day when he was in Winnipeg and missed the train

on which he was to come home that evening, he walked all the way home, arriving just in time to milk the cows next morning."¹⁴¹

The Tully family, all descendants of James and Elizabeth Tully of Musquodoboit, NS, had many members involved in dairying and one family member carries on the tradition today. James Tully obtained W14-13-3W in 1895. He and his brother, Paul Tully, started a creamery on 12-13-4W, near Reaburn, with milk supplied by their own herd of Holsteins. Later, the creamery was closed and James Tully concentrated on farming. He switched to Ayrshire cattle because, although their milk had a lower butterfat content, there was more of it. Eventually, James abandoned shipping milk and cream and went into beef cattle.¹⁴² In the 1940s, a relative, Reginald Tully, took up dairying on SE14-13-3W. A large dairy barn was built in 1947, with an addition made in 1964. Fluid milk was shipped to Silverwood Dairies until 1961, and then to Safeway. The family was given a milk quota of 30,000 pounds (13,636 kg), which the family still holds.¹⁴³

Another Tully, Charles, settled on NW16-13-3W in 1902 and, with six sons, began a large farming operation that included shipping butter to Winnipeg. In 1908, the Crescent Creamery opened in Winnipeg and Charles Tully became the first fluid milk shipper in the area. Milk was shipped daily from Reaburn station. When City Dairy opened, Charles switched his deliveries there. Each morning Charles drove a light horse-drawn dray to the station, loaded with as many as 12-15 eight-gallon milk cans. To house the large herd of Holsteins, new barns were built between 1909-1915. The hip-roofed barn housed 65 cows while a small barn housed the calves. In 1916, the family purchased a milking machine which made it possible to milk 25 cows per hour. The sons started dairy herds nearby. Charles Tully was active in the work of the Manitoba Dairy Association and became one of the first directors of Manitoba Co-operative Dairies.¹⁴⁴

The Archibald McMillan family settled in Meadow Lea district in the 1880s and raised enough milk cows to produce cheese, which was sold in Portage la Prairie.¹⁴⁵ Their daughter, Annie, was responsible for making the cheese and when she married, the venture was abandoned. The family switched to beef cattle. In the 1960s, Archibald's grandson, Alvin, started to farm, with four heifers from his father. From this he built a herd of 200 head. These were gradually replaced with milk cows. Today, Alvin's son, Ross, operates the dairy on SE27-13-3W.¹⁴⁶

James Robertson came west with the Wolseley Expedition and settled on NW3-13-3W in 1885. To start his dairy herd, he had his father ship 65 purebred Ayrshires from BrOockville, Ontario. The family also operated a cheese factory in 1898. German emigrants, Gustav Straub and five other men bought an 1800-acre (729-hectare) farm in the Meadow Lea area in 1929 and purchased a Holstein herd from Sam Sims of Stonewall. The group farmed cooperatively for five years before splitting up. The farm had a modern dairy barn and 36 head of Holsteins. Later, Straub bought a smaller farm in Poplar Heights. He and his wife hand milked the smaller herd for cream and later, fluid milk, to ship.¹⁴⁷

PARKLAND

The land in the Parkland region is suited to raising cattle but the absence of a close market for dairy products made it more reasonable for farmers to engage in mixed farming in the pioneer years. Today, a large number of beef cattle operations dominate the region. In the 1920s-1930s, cream was shipped to the many creameries located in the major centres. Today, Beatrice operates a dairy plant in Dauphin, the only processing plant left in the region. There are fifteen bulk milk producers in the region, but only four of these are north of Dauphin.

In the Dauphin region, Robert Cruise, originally from Lachute, Quebec, started the Cruise Dairy close to Dauphin in 1926. This business grew from 40 cows to a processing plant that prepared and sold 250 quarts (284 litres) of milk daily. The Cruise Dairy was a partnership with Joe Dufault from 1938-1941 when the Cruises left the business and Dufault carried on the name. The business was sold to Manco in 1961. Other dairies close to Dauphin were those of George Buchanan, Jack McKillop, Jim Malcolm, and George Cornwall. Cornwall originally had Shorthorn cattle but after World War I he switched to Guernsey cows. Herbert Coulson followed Cornwall's example, and built a fine Guernsey herd at Sunny Bank Farm, on NW25-26-19W. In 1970, there were 11 bulk milk producers supplying the Manco plant in the town.

The land in the Swan River Valley is fertile and used primarily for grain production, so the lack of dairy producers is not surprising. In the early days a few dairy producers in the valley supplied milk to the substantial number of town dwellers in Swan River itself, and to the lumber camps in the Duck and Porcupine mountains. One of these, the Charles Barker family, arrived in the valley in 1905, and settled on W21-35-27W. One of the family, Bill, owned a dairy farm in the 1960s.¹⁴⁸

SOUTHEASTERN MANITOBA

The dairy industry in southeastern Manitoba was originally centred in the Mennonite communities of Hanover Municipality. At one time, that municipality produced 19% of all fluid milk shipped to Winnipeg.¹⁴⁹ In 1976, Hanover dairymen produced 8% (84, 632 kg) of all milk shipped in Manitoba.¹⁵⁰ The early settlers in the region had concentrated on grain production, but the quality of the land in the region made this unlikely to succeed since too much of the land lacked proper drainage, and much of it was covered with stones and bush. The district's first creamery was established in 1886 and cheese factories followed. In 1891, there were 1,983 cows in Hanover; this increased to 2730 in 1900. Cheese factories increased in number during World War I and then gradually declined because cheese producers in Eastern Canada drove the price down. But Winnipeg's need for fluid milk opened another door for dairymen. Blumenort became a major shipping point for milk to a Winnipeg creamery. The first contract for fluid milk production was given in 1916 to William Laing of Clearsprings who shipped to Crescent Creamery. Beginning in 1923, large amounts of milk from the area were trucked to Winnipeg.



Unloading cream cans at the creamery. These cans were very heavy and required great strength to move around on a daily basis.

Source: Lydia Penner, *Hanover: One Hundred Years*, RM of Hanover, 1982, p.60

A creamery opened in Grunthal in 1927, diverting the product there to such an extent that Crescent Creamery opened a branch in Steinbach in 1929.

J.T. Regehr introduced Holstein-Friesian cows at his farm in Hochstadt, and Alec Baird introduced the Holstein to Clearspring in 1910.¹⁵¹ Today, because few dairy cattle are pastured, a visitor will not see many of these cattle in the fields, but they remain dominant breeds in the region. The Depression brought about an increase in dairy herds, since it was easier to feed grain to cattle and sell their product than to produce grain for sale. Cheese factories once more opened to handle the increase in milk production. The district's farmers co-operatively owned many of these. In 1937, the Kleefeld factory operated 24-hours in two shifts and handled 24,000 pounds (10,909 kg) of milk. That same year the extension of the highway east of Steinbach to Piney allowed farmers from the area around Grunthal to ship their fluid milk directly to Winnipeg.

By 1949, southeastern Manitoba had become the major dairy region of Manitoba. The number of dairy cattle in Hanover alone reached a high of 8760 in 1946.¹⁵² With herd sizes ranging from 4 to 20 head, the average size was 16 cows. In Hanover, dairy products accounted for 25 % of farm incomes by 1951. Dominion Government policies encouraged the switch to fluid milk and as the price of milk rose (\$4.20 per hundred weight or per 45 kg in 1949),¹⁵³ more and more farmers began seeking fluid milk contracts. This led to some uncertainty over contracts among producers and it has been suggested that this was a factor in driving eastern Manitoba farmers to switch to poultry production. Certainly the rise in fluid milk prices led to a decrease in the amount of milk shipped to the cheese factories in the region, causing all but one of them to close. From 1951-1953, the amount of milk processed by the factory in Blumenort alone dropped from 2.3 million pounds (1,045,454 kg) to 383,000 pounds (174,090 kg).¹⁵⁴

Today, a life-sized replica of a Holstein cow greets visitors to the village of La Broquerie, an indication of the significance the dairy industry has played in the economic development of the area. The land, with poor soils, and lots of water holes, once cleared of trees, was well suited for cattle. The French settlers brought with them, from their former homes, a knowledge of dairying. A cheese factory existed at the end of the nineteenth century. In an attempt to stimulate the economy during the Depression, the farmers formed a dairy cooperative and made a deal to open a Kraft cheese factory. This was completely taken over by the Co-operative before World War II. Because a major railway ran through the area, farmers could ship their milk to Crescent Creamery in Ste. Anne. Seeking a better price for their product, in 1931 the farmers made a contract with Hector Berard to haul their milk directly to Winnipeg to other creameries. After the war, milk prices increased as urbanization swelled the population of Winnipeg. It became more economical to ship milk directly to Winnipeg than to send it to the local cheese factory. The cheese factory closed in 1945. Most La Broquerie dairy farmers who could afford it, switched to bulk milk pick-up in the 1960s. The dairy produce from the smaller mixed farms could still be shipped to the Grunthal cheese factory or the Steinbach creamery for a few more years.

The French settlers in Ile de Chene also forced the closure of the Crescent Creamery in their village because the demand for milk in Winnipeg increased the price if they shipped their milk there. Louis Lavallee of St. Vital started to collect local milk and haul it to City Dairy. Later it was sent to Modern Dairy, St. Boniface Dairy or the People's Coop. Farmers living further east, in the Ross - St. Genevieve area, were able to ship their milk to a local cheese factory between 1909 and 1923, before it became more profitable to ship cream via the Greater Winnipeg Waterworks Department Railway to St. Boniface.¹⁵⁵ In 1946, Lucien Desrosiers started transporting milk from the region to creameries in Winnipeg. He and his brother ran two trucks

on the routes. He gave up this career in 1958 because the job was just too difficult: the milk cans weighed 105 pounds (48 kg) and he only weighed 125 pounds (57 kg)!¹⁵⁶

St. Pierre, another French settlement, also depended on dairy cattle for its economy. A cheese factory opened here as early as 1886, and the district had as many as four operating at one time.¹⁵⁷ The first butter plant in the West was started here. The product won first prize at an exhibition in Ottawa and second prize in Toronto in 1887. The dairy industry was revitalized in the 1930s when three cheese factories and the St. Pierre Dairy Co-operative handled as much as 45,000 pounds (20,455 kg) of milk per day.¹⁵⁸ One year the Co-operative alone took in over three million pounds (1,363,636 kg) of milk.

The Whitemouth area today has twelve bulk milk producers. This is not unusual since the land is well suited for forage crops. But the fact that a dairy industry developed in the region early in the 20th century is surprising. Its existence can be explained by three factors. First, many of the early settlers in the area were Danes, Finns, or Germans who emigrated from Russia or Poland, many bringing with them some knowledge of dairying. The second factor was that Whitemouth was located along the mainline CPR, and represented the last agricultural area before the Canadian Shield enveloped Western Ontario. Much of the milk, butter and cream produced in the Whitemouth area was shipped eastward, to places like Kenora and Dryden. It was used to supply the lumber camps in the forests of southeastern Manitoba and Ontario. Thirdly, in the first quarter of the century, large construction projects for hydroelectric power and railroads added to the demand for the dairy products of Whitemouth. Municipality.

Life at the edge of the Canadian Shield was hard and none of the early pioneers were able to concentrate on farming alone. All male family members had to seek employment in the construction, railway, or lumber camps at some point. Once the trees had been cleared and the muskeg burned, dairy products prepared by their wives became a constant source of income. Several families concentrated on dairying after the pioneer period. With cheap lumber readily available, farmers could construct large barns, many of which still dot the landscape. Bill Altstadt ran a dairy farm for over thirty years, delivering milk to local restaurants and residents for five cents a quart (5.5 cents per litre) in the 1930s.¹⁵⁹ Sid Meltzer started a service hauling farmers' cream to Beausejour.¹⁶⁰ Emil Merke started a dairy farm in 1947 with 15 cows, shipping his milk to the Safeway Lucerne plant in Winnipeg.¹⁶¹ The Schultz family had a dairy farm near Seven Sisters, delivering milk and cream to the people living in the townsite.¹⁶² Jake Stark started a dairy farm in 1965, shipping his milk to Grunthal, and arranging for 15 neighbours to ship their milk there jointly by transfer. Henry Steiner took over his father's farm in 1925 and changed it to a dairy operation. He shipped his cream to Kenora by CPR.¹⁶³ Most local families however, milked about eight cows, and shipped the cream.

WESTMAN

Dairy farms in the Westman region were generally located near the city of Brandon, where processing plants existed and where a sufficient urban population awaited milk delivery. In the area south of the Riding Mountains, however, the land lent itself to raising cattle, either dairy or beef. Before 1950, many farmers in the region raised a combination, milking enough cows to ship substantial amounts of cream. Jack Stephen of Cardale had a substantial herd of purebred Ayrshire cattle, purchasing the first in 1922. He began successfully exhibiting his Ayrshires in 1929 at the Brandon Fair and continued to exhibit his cattle into the 1960s. He had his herd on the Record of Performance (ROP) program and his Ayrshires often scored as the top-performing herd in the province. Three generations of the Stephen family were involved in the dairy-cattle industry.¹⁶⁴

On the Carberry plains, cattle raising was an important industry before the advent of potato contracts. Most of the farmers raised beef cattle but some did raise dairy cattle as well. In 1959, Jersey breeders were Alden McDonald, Jim Mills, Art Evans, Russell Tolton, Ivens Reddon, S.J. Meneer, A.E. Gardner and Andy Currie. Joe Graham raised Holsteins while John Pool of Sidney owned a herd of Guernseys.¹⁶⁵ By 1980, most of the dairy farmers in the area had converted to Holstein herds and fluid milk production. Most herds consisted at least 25 milking cows.¹⁶⁶ Families with dairy herds included Archie McIntyre of Worby, Ivens Reddon, Hunter Witherspoon, Marilyn Graham and Allan Reynolds of Carberry, Eldon McDonald of Brookdale. In the Erickson area, two families have been involved in the dairy industry for over twenty-five years. The Gordon Hammells started a Holstein herd in 1975 and are still bulk milk shippers. Ernest Smith, and his son, Bruce, started bulk milk shipping in 1975, from their dairy farm on W23-17-18W.¹⁶⁷

There were several families who raised dairy cattle in the Douglas area. Robert Brown began in 1944, on SE20-10-17W, first selling cream, but switching to selling milk to Manco Dairy in Brandon in 1946. After 1948, and the introduction of the quota system, the Browns were allowed a 20,000-pound (9070-kg) quota per month. In 1964, they installed a bulk storage tank. Gradually they switched to a purebred Holstein herd and in 1957 placed them on a ROP schedule. Because some of their cows produced up to 29,000 pounds (13,152 kg) of milk per year, their purebred cows were much in demand among American dairymen.¹⁶⁸ In 1964, the family sold their quota but continued to ship cream from their remaining herd until 1973. Jacob Bullee started dairy farming on 25-10-18W in 1947, and later on 22-10-17W. The dairy herd was sold in 1959.¹⁶⁹ John Muirhead delivered milk to Camp Shilo. His nephew, John Jenkins, began in 1935 to deliver milk to the village of Douglas for his uncle. After his uncle's death in 1939, Jenkins continued the delivery business until 1943.¹⁷⁰ Jim Richardson ran a dairy farm on 28-10-17, south of Douglas, selling his herd to Sam Gurr in 1964.¹⁷¹ Other dairy families around Douglas included the Sinclairs, James, Fieghens, R.J. Mitchells, and Plowmans.¹⁷² Today, most of the dairy herds in the Douglas region have been replaced by beef cattle.

There are still 19 functioning dairy farms in the Brandon area. Many of these are third and fourth generation-owned. Although the land around Brandon has great grain-producing potential, after 1900 the developing urban centre there provided a market for dairy products. A major railway and supply centre, Brandon also was the site of a college, a jail and a mental institution, all of which required dairy provisions. Oliver Chevins and Morgan Morgan ran a dairy on NE23-10-18, supplying milk to the Brandon Mental Hospital from 1914-1925.¹⁷³ There were many dairies in the Brandon area, including the Brandon Creamery on SE21-10-19W. Ed Fotheringham purchased this creamery in 1924, as well as the Brandon Creamery Jersey Farm, on 34-9-19W, and SE21-10-19W. The Fotheringham Dairy also owned N27-9-19W, NW28-9-19W, and E33-19W, all purchased in 1935. Fotheringham hired Alex Arthur to manage the dairy in 1942. In 1950, Arthur established his own dairy farm with a herd of Jerseys he called Gentrice Jerseys, meaning "gentle breed". The farm, on NW8-9-18W, was operated by the family into the 1980s.¹⁷⁴



This is a large dairy operation near Brandon called Glencarnock Stock Farm. It was owned by Ed Fotheringham who incorporated it into his dairy and creamery operations. Many farmers gained their dairy experience here before establishing their own dairies. The cattle pictured are a mixture of beef and dairy breeds.

Source PAM, Jessop Collection 45 #N5336

Stuart Smythe bought S26-10-18W in 1910 and established a stock farm there. His son, Wesley, who was very active in the Holstein-Friesian Association for fifty years, took the farm over in 1938 and raised Holsteins.¹⁷⁵ He sold the operation to Lyall Brown in 1960. Eventually, the Browns changed their Holstein dairy cattle operation, which they called Brownstow Dairy, to Simmental beef cattle.¹⁷⁶ Robert Petrie Brown came from Scotland in 1908 and began working at Glencarnock Farm on E33-9-19W. In 1935, the farm was sold to Ed Fotheringham. Robert P. Brown purchased Glencarnock Farm in 1949. He and his sons, Marshall and Allen, expanded the dairy operation. The Browns still operate this dairy farm.¹⁷⁷

John Hutton arrived in Brandon in 1910 from Scotland and gained dairy experience on Glencarnock Farm before starting his own dairy in 1923 on NE5-10-19W. He was a dairyman until his death in 1950.¹⁷⁸ Fred Stanley started a dairy on NE5-10-18W in 1921 and sold milk in Brandon for many years before moving to Whitehead Municipality.¹⁷⁹

Wit Kain, and later John Kain, had a dairy farm on E27-10-18, near Chater, from 1944-1972. They began shipping their bulk milk to Brandon Co-op (Manco) in 1949.¹⁸⁰ Charlie Grant turned the family farm, on 34-10-18W, near Chater, into a dairy operation in 1944, operating it until the late 1970s. The Fred Curtis family had a dairy east of Chater, and began shipping milk to Brandon in 1946. Their sons, George and Bruce, took over the dairy in 1971.¹⁸¹ The Robert S. Brown family on SE20-20-17W began to ship milk to Brandon dairies in 1945, and continued for 18 years. They had a Holstein herd registered on the ROP plan. In 1959, they sold the herd to the Birtle Indian School at Birtle.¹⁸² John Campbell had a dairy on SE33-10-18 for 29 years, beginning in the 1930s. Norman Keith Connon operated a dairy farm for 35 years on SW15-10-18W beginning in 1943. He had begun his career as a dairyman at age 14, delivering milk door-to-door in Brandon for his father. He was also very active in the Brandon Milk Producers Association.¹⁸³

More recent comers to the dairy field were the Hugh Jameson family who purchased a dairy herd of 22 cows from George Beach in 1960 and remodelled the farm buildings on E7-9-19W to house a dairy operation. The Jameson family still has a dairy quota.¹⁸⁴ Brandon View Stock farms, owned by Ivan Hamilton, was started in 1933 on 34-10-19W. Among its agricultural assets was a dairy herd. In the 1960s, much of the land from the farm was used to build a portion of the Trans-Canada Highway and for suburban development.

Blake Donohoe and his sons moved to Brandon in 1970, branching out from the Donohoe dairy enterprise in Petersfield, called Donohoe Farms. The Brandon farm, on SW16-10-19W, was named Donfield Farms Ltd. The family further expanded in 1977 when the Donohoes purchased a dairy farm at The Pas from Modern Dairies. Donfield Holsteins in Brandon is one of the top herds in Manitoba. The family has played an active role in promoting the Holstein breed, and in dairy associations.¹⁸⁵ Donfield Farms expanded its holdings in 1970 when it purchased Samson Farms Ltd., on SW16-10-19W. That dairy enterprise was created by Sam Gurr and his family who entered the dairy business in 1956 by renting the farm of Ed Fotheringham, among others. The farm, located in west Brandon near 42nd Street, had a 80,000-pound (36,281 kg) quota and a modern four-stall milking parlour. The Gurr family won many dairy exhibition awards in the 1960s. Donfield Farms remain active in the dairy field.¹⁸⁶

A Holstein dairy farm, established on NW8-9-19W in 1955 by Walter Demanski, was purchased by Laurie Harp in 1974. He brought with him a small herd of Brown Swiss, a breed he had grown up with in Treherne, but he changed to a herd of registered Holsteins, some of which were purchased from the Ziona Holstein Farm in Brandon. The Harps are still active in the dairy industry.¹⁸⁷

The Westman Dairy began operating on SW27-9-18W in 1976, and the Ingaess Dairy Farm on SE22-09-19W was established in 1973. Both are still functioning.

Elton Municipality is located north of Brandon, and farmers in that district took advantage of this proximity to engage in dairy farming. Robert Birmingham settled on S6-11-18W in 1907. In 1912, he acquired a part of the Ash Leaf Dairy routes. He and his sons operated the R.A. Birmingham dairy from 1912-1939, delivering milk in Brandon directly from milk cans. By that time, the introduction of glass milk bottles, pasteurization and homogenization made the Birmingham decide to forego home delivery service, and produce bulk milk to sell to creameries. Shortly afterward, the family switched to beef cattle.¹⁸⁸ In the 1930s, Austin Brownridge, on 2-11-19W sold milk to Wheat City Dairy. In 1947, he too switched to beef cattle.¹⁸⁹ Cliff Buckley had a Jersey dairy business on 15-11-18W in the 1950s.¹⁹⁰ Ron Griffin had a dairy farm on 1-11-19 from 1951-1962, when he sold his dairy herd to convert entirely to grain production.¹⁹¹ Donovan Hockley started a dairy farm on N21-11-19 in 1944. He added a large dairy barn in 1951 with the necessary equipment for modern dairying, including a pipeline milking system. Today, this dairy is carried on as Hawklea Holdings by his descendants.¹⁹²

In 1936, George Sheach, with dairy experience from his native Scotland, established a dairy farm on S22-11-19. He began selling fluid milk in 1948 and, in 1950, began raising purebred Ayrshire cattle. Sheach was director of the Manitoba Ayrshire Association for 18 years, as well as Honorary President of the Ayrshire Breeders of Canada. The operation was taken over by his son, George Junior, in 1973.¹⁹³ The Hillis family has lived on 18-11-19W since 1887. Today, fifth generation descendant, David Hillis operates a dairy farm on the property.¹⁹⁴ Jim Nichol started a dairy farm in the 1930s, eventually settling on E16-11-19, where his family still runs a fluid milk operation.¹⁹⁵ Dan McDonald and his son Gordon started a dairy farm on NE26-9-10 in 1935 that is still run by the family.¹⁹⁶

Turtle Mountain Municipality is filled with rolling hills and waterholes, making it ideal cattle country. The pioneers who settled the region, however, were predominantly from the British Isles and did not bring a dairy tradition to their new homeland. The region was also fairly distant from an urban market. Therefore, most of the agriculturalists in the region have concentrated on beef cattle. The few dairy farms in the area are of a recent vintage. The Hullett dairy Farm was established in 1975 by Keith Yeo, on his parents' farm W28-3-16W. In 1977, they built a modern dairy barn for their 68 cows. The Yeos were instrumental in founding Mound Milk Transport Co-op Ltd., which won producers the right to transport their own milk. Currently, there are three dairy farms in the region: Lakeside Dairy on SE06-02-16W; Ken Stockwell on SE18-01-16W; John Wolf on NW30-2-15W.¹⁹⁷

WINNIPEG

The Red River Valley provided excellent pastureland for cattle, but more importantly, it was located near a large urban population with a demand for dairy products. One of the earliest milk pedlars in the city was William Waugh who began taking a milk wagon through the streets of north Winnipeg in 1885. Later, he moved to Bird's Hill and from his dairy farm there, he shipped milk to Winnipeg from 1914-1946.¹⁹⁸

In the early 20th Century, the Belgians became the largest single group of dairymen in Winnipeg. Although many Belgian immigrants established dairy farms in and around Winnipeg, their operations were relatively small. They seldom had more than 50 cows and typically they sold their products independently. One dairyman recalled:

Each morning after milking time we would finish our breakfast, clean the barn, and then my father, starting on a small scale, would take milk from our dairy at Kingston Row across the Red River on a barge in summer. From there he followed a trail through River Park on to Osborne Street and into Winnipeg. He supplied the boarding houses and hotels with milk. In winter he would go around and over Norwood Bridge.¹⁹⁹

This dairyman, and many others, used the "loose milk" delivery system. They loaded their wagon with eight-quart (nine-litre) cans of milk and went door to door on streets within their delivery area. At each house, the lid of the milk can was filled with milk poured from the can. The lid held exactly a quart (1.1 litre), the amount each housewife wanted each morning. "In winter the inside of the lid would sometimes gather a thin coat of ice. When this happened, we would go in the kitchen, melt the ice with warm water to insure the exact amount of milk. Otherwise you heard about it."²⁰⁰ When bottled milk came into vogue in the 1920s, the costs increased and many of the small dairies in the Winnipeg area began to sell their milk to larger dairies, such as Crescent, Modern, Standard and St. Boniface creameries. The 1930s brought about compulsory pasteurization of milk, further increasing costs to the extent that many dairy farms in the Winnipeg area were sold after the first generation of Belgian-Canadians retired. Much of the land once housing dairies around the city was gobbled up by urban expansion.

In 1890, Constant Bossuyt bought the Northwestern Dairy, one of the earliest established in the Winnipeg area, and renamed it the Manitoba Dairy. The family operated the Bossuyt Dairy, relocated in modern times to Oak Bluff, until 1982, when the dairy herd and quota were sold.



The Cummings Dairy Farm near Winnipeg, pictured here in 1916, is representative of the many such operations that existed around the city prior to 1950.

Source: PAM, Jessop Collection, photo # 217



Horse-drawn milk wagons were very common in the streets of Winnipeg prior to World War I. Many of the farmers from the area surrounding Winnipeg rose to deliver milk at 4:00A.M. Because the wagons were not heated, milk delivery was a very cold job to have during the winter.

Source: Rosser Centennial History Book Committee, *RM of Rosser – The First Hundred Years 1893-1993*, p 157

The Van Walleghams, a family of six brothers began arriving from Belgium in 1898. A. Van Wallegham began working with the Bossuyts in 1902. Then he moved to the present Cambridge Street area and started the Royal Dairy in 1904. The brothers rented pastureland on the prairie that would become River Heights. The young sons were put to work herding the cattle or driving the milk delivery wagon. In 1936, the Van Walleghams bought their first truck for delivering the milk. By then, they had moved their herd outside the city to the Elm Creek area, although their processing plant remained in River Heights. The company offered its customers raw and pasteurized milk until 1950, when, as a result of the 1950 Flood, the dairy began to concentrate on pasteurizing milk for all the small dairies around Winnipeg.

Austrian emigrant, Joseph Blackner, built a dairy farm on Riverlot 9 in Old Kildonan in 1927. Called the Sun Dial Dairy, the operation had 25-30 milk cows, milked by hand, with the milk delivered in Winnipeg. Today, the former site of the dairy forms part of the Maples subdivision.²⁰¹

Ted Townsend and Les Millington, in 1936, developed a herd of Holstein-Friesians, called Rockwood Holsteins. They placed their herd on the Trappist Fathers' 1500-acre (608-hectare) farm at St. Norbert. Ted ran the farm, charting and indexing each cow while scientifically rotating the crops to grow the best grass and clover feeds. During the 1940s and 1950s, 1000 to 1500 tons (90,909 - 1,363,636 kg) of hay were stacked with sweeps annually. The hay was run through a cutting box and blown into the barn as required. The milking system, overseen by Martin Carrico, was labour intensive. One man was assigned to each cow and he got the cow ready for the milking machine so that the milk came fast, and very little stripping took place. The cows were milked three times a day, with each milker working 2.5 - 3 hours for each period. The milkers were free one-half day per week and two days per month. There were 87 stalls in the milking barn and 16-17,000 pounds (7,273 - 7,723 kg) of milk were produced in each stall per year.²⁰²

Of the many dairies that once were located near Winnipeg, only a few still exist today. All are located in neighbouring municipal jurisdictions. These are the Grenkow Dairy Farm, on SW2-12-2E, and Allan Grenkow's, on NE3-12-02E, in Rosser Municipality. South of the city, the Van Wallegham family, which once operated a large dairy in Winnipeg, is now represented by descendant Ronald Van Wallegham, who has a bulk milk operation on NE32-7-3E, near Glenlea. Brady Farms, on SW11-9-2E, is located in the RM of Macdonald, southwest of the city.

CHEESE FACTORIES

Cheese utilizes milk for processing, whereas cream is processed into butter. Because milk spoils more quickly than cream, processing plants had to be located fairly close to the farmer so it could be delivered each morning. Cream could be held and shipped longer distances. Most of the cheese produced at local plants in the early years was returned to the farmer for his personal use.

The first cheese factories opened in 1882 in Stonewall and Rapid City. Very soon, every community was searching for a cheese maker so they could open a factory in their neighbourhood, to which local farmers could sell their excess milk. Many farmers had previously fed the excess milk to their livestock.

The provincial government was anxious to promote cheese making in rural communities and, in 1893, it offered a \$500 loan to each new creamery and cheese plant that opened in Manitoba.

It also exempted the land, machinery and buildings of such establishments from taxation. This legislation proved a great stimulus to the opening of new dairy-processing plants.

In 1890, it took one gallon (3.8 litres) or 10 pounds (4.5 kg) of milk to make one pound (.5 kg) of cheese, which might sell for 14 cents. After the cheese makers deducted their profit and operating costs (around 2 1/4 cents per pound or 5.6 cents per kg) the rest of the money realized from the sale of the cheeses was divided among the patrons, according to the weight of the milk they sent to the factory between May and October.²⁰³

In the early 1900s, most of the cheese factories were located in southern Manitoba because that was where the majority of dual-purpose herds existed, belonging to farmers with a dairy background: Mennonites, Belgians and French Canadians. S.M. Barre, former lecturer on dairy farming for the Department of Agriculture, opened cold storage facilities on King Street in Winnipeg to handle butter and cheese produced in that area.²⁰⁴ In 1895, he shipped two carloads of cheese to Great Britain, one from Strathclair and one from Otterbourne. There were 52 cheese factories operating at that time, producing a total of 1,553,000 pounds (705,909 kg) (about 30,000 pounds [13,636 kg] per factory) of cheese, which sold for 6.9 cents per pound (15 cents per kg).²⁰⁵ Due to a glutted market, after 1900 the number of cheese factories began to dwindle, from a high of 86, to 26 in 1920.²⁰⁶ That year, Manitoba cheese captured first prize at the Toronto Exhibition.

In 1909, Isadore Villeneuve was appointed Cheese Factory Inspector, as well as instructor at the Manitoba Agricultural College. A former inspector from Ontario, he drew up plans to rejuvenate the industry. Although his efforts were commendable, it was really economic circumstances that played the greatest role in elevating cheese production figures. The Depression forced farmers to return to milking cows, even though milk prices were very low. The cheese factories that still existed in 1930 needed serious up grading, and Villeneuve made plans and specifications to do this. Some new plants were built, and others expanded, especially during the war when the world market called for increased production. Villeneuve retired in 1944, but during his time he started two incentives, aimed at improving the quality of cheese produced in local plants.

The first was a Cheese-making Competition, organized in 1923, and continuing annually until 1933. The Banque Canadienne Nationale presented a silver cup to cheese makers with the highest percentage of No. 1 grade cheese, and for the best kept plants and their surroundings. A second competition, also sponsored by the Cheese Specialist of the Dairy Branch, awarded a prize for the best box of factory-produced cheese, consisting of triplets weighing not less than 26 pounds (11.8 kg) each, and produced in October of the year of the judging. By stating a month, it meant that the cheeses entered in the competition would be equally aged.

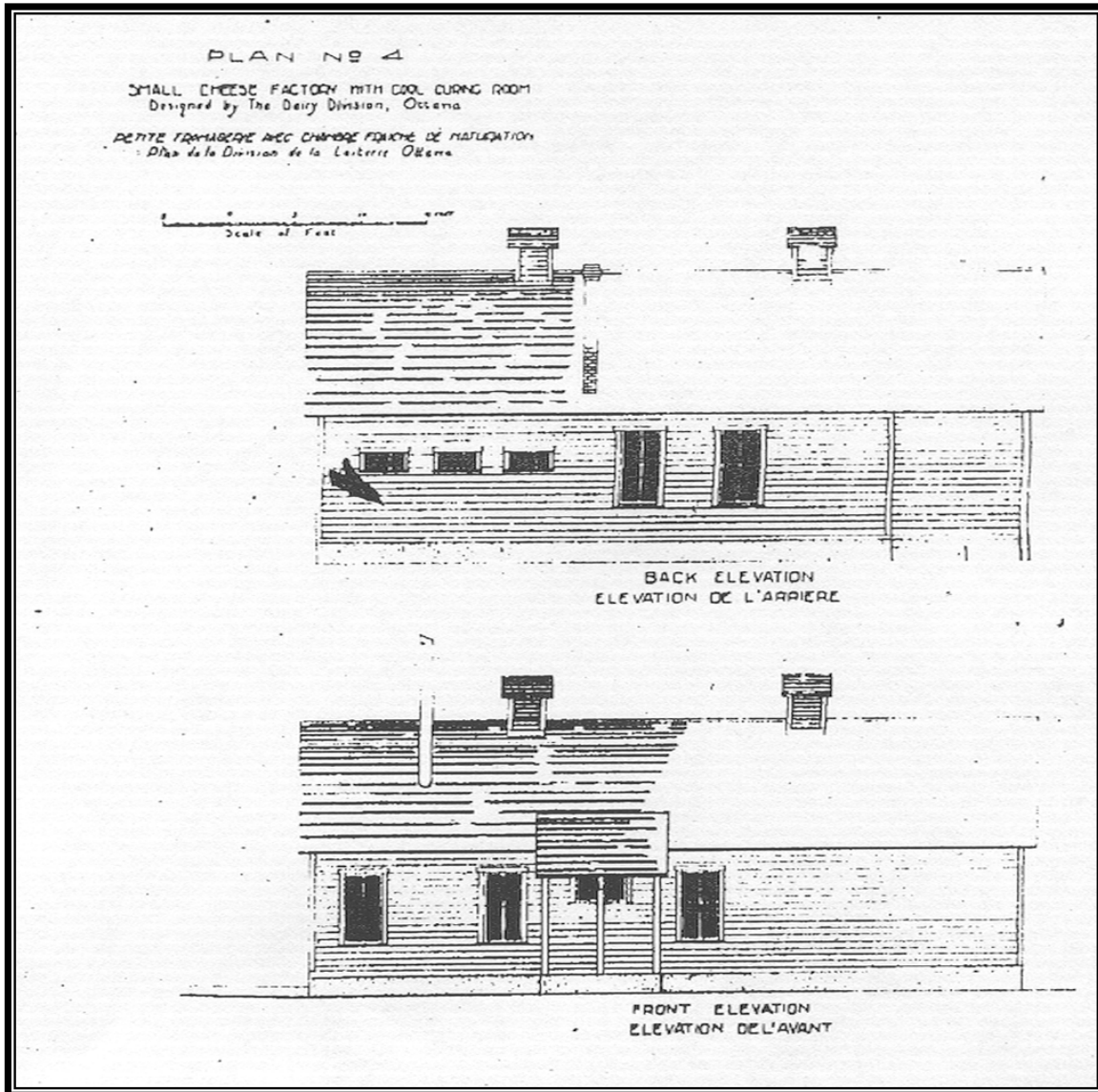

Design for a cheese factory as prepared by the Dairy Division of the Department of Agriculture of the federal government and made available to local farmers in the 1890s.

Source: George H. Barr and J.B. Bouchard, *Cheese Factory and Creamery Plans*, 1914

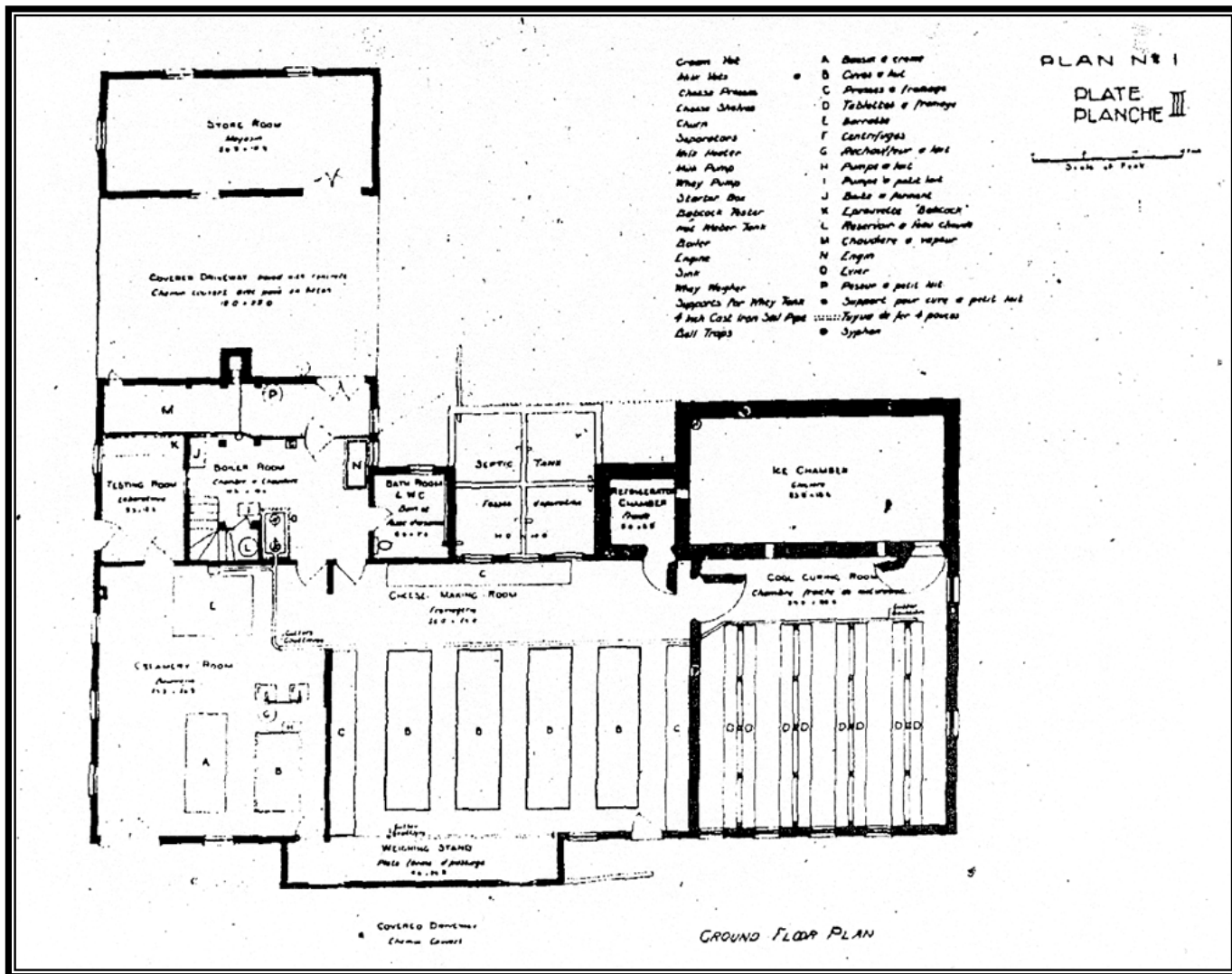

Interior plan for cheese factory, as prepared by Manitoba Agriculture, Dairy Division in 1914
 Source: George H. Barr and J.B. Bouchard, *Cheese Factory and Creamery Plans*, 1914

Cheese production was of a cyclical nature, because the cows had production cycles. Most plants did not operate during the winter, when the amount of milk produced was smaller. The manager of the Blumenort cheese factory described the operation of his plant this way:

Each month we produced 27,000 lbs. [122,723 kg] of cheese. About 35 pounds [16 kg] whey butter was produced per day. At the most we received about 3,000,000 lbs. [1,363,636 kg] of milk per month. Most of the milk was received in May and June. During the winter months milk production dropped, and sometimes we received as little as 120,000 lbs. [54,545 kg] of milk a month.

Milk was received in eight-gallon [24-litre] cans. In the first years the cans were returned to the farmer unwashed so the farmer had to wash them himself. Later the cans were sent along a conveyer (upside down) and steam-washed, on a mechanism built by C.R. Plett. This was a great improvement for the farmer.

The milk was taken to the cheese factory in horse-drawn trailers in summer and sleighs in winter. Often farmers would pick up milk for their neighbours and deliver it to the cheese factory.²⁰⁷

Cheese was made from whole fresh milk that was run into long vats, where it was sterilized. A mother culture was added to a starter batch and allowed to coagulate before being returned to the vat which contained as much as 7000 pounds (3182 kg) of milk. The rennet²⁰⁸ was added and, with controlled heat and proper turning, the cheese thickened. The whey was drained and the curd cut into finger sized chips, salted and poured into round forms. Some cheeses weighed 30 pounds (13.6 kg), some 90 pounds (41 kg).²⁰⁹

Cheese production increased tenfold during the depression and war years. In fact, in 1942, the cheese output per factory (213,620 pounds or 97,100 kg per factory) in Manitoba outranked factories in either Quebec (119,552 pounds or 54,342 kg per factory) or Ontario (210,750 pounds or 95,795.5 kg per factory). Since the latter two provinces had more factories than Manitoba, its total cheese production kept Manitoba as the third ranked producer.²¹⁰ In 1942, there were 24 cheese factories in the province, the highest number ever. None of the cheddars were allowed to age very long before they were sold. It was during the Depression, in 1935, that cottage cheese became a product of a cheese factory, as opposed to being a homemade concoction. Factory production of cottage cheese rose steadily from 1948 to 1959, due more to a reduction in the number of families producing their own cottage cheese than to an increased demand for the product.

After the war, cheese production fell quickly, and the number of factories dropped to five. Milk production levels in general fell, as high beef and grain prices invited farmers to turn to grain production and beef cattle. These economic endeavours required less labour, of which there was a shortage after the war. The postwar period marked the beginning of rural depopulation as people left the country to live in cities. Further, prices paid for fluid milk were high enough to remove cheese making as a viable alternative.

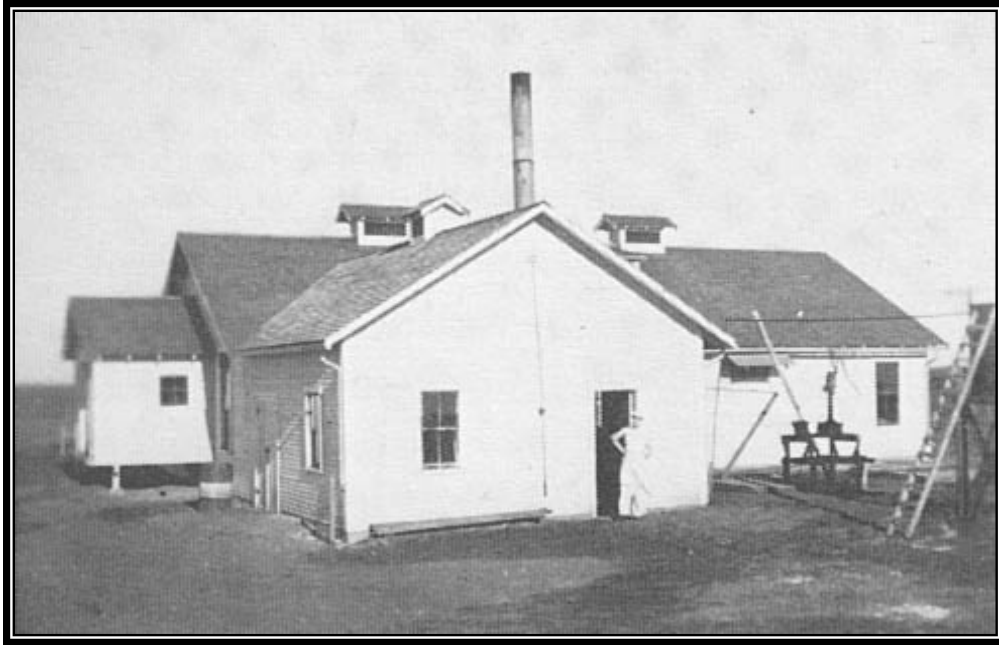

Arnaud cheese factory building, in 1972. This building is still extant.
Source: Arnaud Historical Society, *Arnaud through the Year*, pp.99 & 359

In the 1960s, cheese production in Manitoba began to make a comeback. In 1965, Manitoba imported six million pounds (2,727,273 kg) of cheese. Cheese manufacturers began to aim at making Manitoba self-sufficient, as opposed to tapping into the huge export market. From 1962 to 1964, Manitoba's cheese production rose from 200,000 pounds to 951,000 pounds (90,909 - 432,272 kg).²¹¹ Demand was so great that the Manitoba product was worth a premium of one cent per pound (1/2 cent per kg) over Ontario cheddar at the wholesale level. The combination of good price and consumer acceptance brightened the future of the cheese industry in Manitoba. At that time there were five cheese-producing companies in the province: Souris Creamery, New Bothwell, Grunthal, St. Boniface, and Winkler.

In a standard cheese factory of the 1920-1950 period, the milk was received on a raised platform at the end of a driveway. Here, eight-gallon (24-litre) cans were lifted off wagons or trucks. The milk was generally brought directly from the morning's milking and was therefore still warm. The milk was dumped into a 200-gallon (91-kg) weigh can. The cheese-maker would sniff it to make sure it was sweet. The amount of milk weighed was recorded for each client before a tap was opened to allow it to drain into the cheese vats, each with a capacity of 7,000 pounds (3,181 kg). An attached strainer caught any sediment.

By opening the steam valve, which led to the jacket around the tinned iron vat, the milk in the vat was heated to around 88 degrees Centigrade. A starter and rennet was added to the vat, and a canvas cover placed over it. This starter was prepared in a separate room and reused until it lost its activity. By the 1960s, it became necessary to use a different culture every day to counter the effects of a plague build-up (lactic acid inhibiting organism). These cultures were freeze-dried cultures held in liquid nitrogen. By then, the manufacturer had switched from the eight-gallon (24-litre) cans of milk to smaller batches of reconstituted milk, made from water and skim milk powder pasteurized at 88 degrees Centigrade for one hour and then cooled to a setting temperature of 21-25 degrees Centigrade. The frozen culture was allowed to sit in the milk for approximately 12-14 hours in order to ripen. In 1974, the manufacturers began adding frozen cultures directly to cheese vats filled with milk. This eliminated the necessity of preparing bulk cultures.

Out of every one hundred pounds (45 kg) of milk, eight to ten pounds (3.6-4.5 kg) of cheese was produced. Most of the whey, 97%, was water and had to be discarded. When the whey was ready, it was drained and put through a separator to remove any butterfat. Then it was pumped into a six to seven-foot (2-m) high whey tank. The material removed in this process was either returned to the farmer for swine feed, or drained off into a ditch where it produced a very strong odour, which was particularly difficult to stomach in the summer, especially if the wind was blowing in your direction. For this reason, the cheese factory was always located in the countryside. The disposal of the whey remained a problem for decades, until a process was developed for drying it to produce a powder suitable for animal feed.

When the whey had become curd, it was pressed in the cheese press in galvanized metal hoops that produced a 90-pound (41-kg) round cheese. These were stamped with a date, factory number and vat number, and placed on a well-varnished shelf in the curing room. The cheeses were turned every day, and after a short curing period, were shipped on a weekly basis to cold storage facilities. Here, they were boxed in the old-fashioned cheese boxes made of elm veneer, mostly produced at a box factory in Blumenort.



Kraft-Phenix Cheese plant in La Broquerie

Source: *La Paroisse St-Joachim de La Broquerie: 1883-1983*, p.79

The cheese-making process became more mechanized after 1950. The change in culture methods (mentioned above) was accompanied by new machinery, such as mechanical agitators, which eliminated the hand turning of the whey by fork, which, although it kept him fit and wiry, occupied a large amount of the cheese-maker's time. The capacity of the vats was increased from 8-10,000 pounds to 20-40,000 pounds (3,636 -4,545 kg to 9,091 - 18,182 kg). The new vats had stainless steel interiors and the exteriors were either stainless steel or painted iron sheeting. Cheddar tables, which held the contents of more than one vat, were introduced. More milk could then be handled at a faster rate. Automatic cheddar table unloaders and hoop fillers were also added, eliminating much of the backbreaking work of hand pailing the curd into the hoops. The cheese was now packed in squares and stored in cardboard containers.

In a modern factory, the cheddar cheese process follows these steps: Starter, rennet and colour are added to pasteurized and homogenized milk and allowed to set a firm curd for 30 minutes. The curd is then cut into small cubes, warmed and stirred until it reaches 38 degrees C (100 degrees F). The whey is removed and the curds are left to fuse together. Next it is cut into slabs and turned and piled into layers. These slabs are cut in a curd mill, salted, drained, placed in cloth-lined metal hoops, and pressed. The cheese is dressed and dried for 3-4 days at 55 degrees C (130 degrees F), then dipped and wrapped in plastic film. It is cured for several months, or up to a year, at 7 degrees C (45 degrees F).²¹²

Traditionally, the majority of cheese produced at Manitoba's many factories was cheddar. In 1935, cottage cheese became another product produced for commercial sale. Previously, the farmer's wife produced her own cottage cheese, by hanging the curds on the clothesline in a cotton bag until sufficiently dried. A cheese-maker in Lorette, Petro Collarine, began producing Parmesan cheese in the late 1940s and exporting it as far as South America.²¹³ Other cheese types produced between 1950 and 1970 were Edam, Gouda, Trappist, Primost and Skyr. Since 1970, the range of cheeses has grown to include Mozzarella, Caraway, Colby, Monterey Jack, Brick and other hard cheeses. Processed cheese was made in Manitoba in the 1950s but is no longer manufactured here.

By 1975, Manitoba cheese-makers were producing over 10 million pounds (4,545,454 kg) of cheese and the number of factories had increased to eight. Cheese prices had more than doubled in the previous ten-year period.²¹⁴ The increased production was caused by an increased consumer demand, which can be attributed to a comprehensive marketing campaign by the Dairy Farmers of Canada and the National Dairy Council, called the October Cheese Festival. Canadians have become more aware of the nutritional value of cheese, and it has become a common ingredient in sandwiches, the mainstay of workers.

A change in packaging also played a role in making cheese a more popular product. For years, cheese had sat on counters of country stores, with slabs cut off as demanded by the customer. In 1954, Manitoba producers began to sell the cheese in 40-pound (18-kg) blocks to stores. It was then re-wrapped and re-cut into smaller Cry-o-vac packages. Consumers liked the cleanliness of such products. Also, in this same time period, factories began to produce processed cheeses and, in the 1980s, specialty cheeses, which were a great hit. In the 1970s, consumption between the three types of cheeses - processed, cheddar, and specialty - was almost evenly split.²¹⁵

The life of a cheese-maker was very demanding. Because the milk was delivered early and had to be pasteurized before the cheese-making process could begin, he started work around 6:30 a.m. and worked constantly until 6:00-7:00 p.m. The work was in a hot indoor plant. The hand turning of the curd, and lifting of the milk cans and cheese boxes, required a great deal of

physical strength. Also, a certain amount of experience was needed for the cheese-maker to produce a fine grade of cheese. Without a first class cheese-maker, a cheese factory was bound to fail, as so many of them did in the late 19th century.

CREAMERY OPERATIONS

In the early years of a district, when no processing plant existed for transforming dairy products into marketable items, farmers churned their own cream into butter, and took it to the local storekeeper to exchange for other provisions. The merchant would then sell it to other customers. Dash churns (a crock with a wooden plunger), were used by the farmer's wife or children. Later, barrel churns were used. These were oak barrels with clamped lids. A cork could be pulled to release gas, and to pour off the buttermilk at the end of the cycle. Some farmers trained their dogs to power the barrel churns. One such case was that of farmer Walter Burns of Sanford. His dog "Sport" was required to churn every day but Sunday. Not surprisingly, the dog always hid on Monday mornings!²¹⁶

Five gallons (19 litres) of cream could be churned at once, creating 21-24 pounds (9-11 kg) of butter. Once the butter had formed, it was washed twice and then put into a wooden bowl where the salt was worked into it with a wooden paddle. To remove the streaks from the butter, it was left six hours and reworked. The butter was then rolled or printed into pound blocks and wrapped in parchment paper. The quality of this butter varied, according to the care taken by the maker. One Manitoba farm wife took such care to produce her butter that she won the title as "Champion Butter Maker of Manitoba" in the early 1900s. When Mary Coates, of the Morris area, heard that the De Laval cream separator company was sponsoring a butter competition, she determined to win the \$50 prize.

She and her son, Fred got up at four a.m. (before insects were around) and washed all the cows' udders, using scrupulously clean hands for the job. The skim milk was fed to the calves, and when the cream was the right age and temperature, she would churn it. Mrs. Coates claimed there was a special technique of "spanking" the butter, so as to remove all the water without breaking the butter cubicles - which makes it greasy. Finally the championship butter was examined and displayed in Toronto, and after a year in cold storage in a crock -- it still maintained all its prize-winning qualities. She was declared the Champ, being awarded a silver cup, and a \$50.00 cash prize. Thereafter she and her family were barred from entering any such competition again!²¹⁷

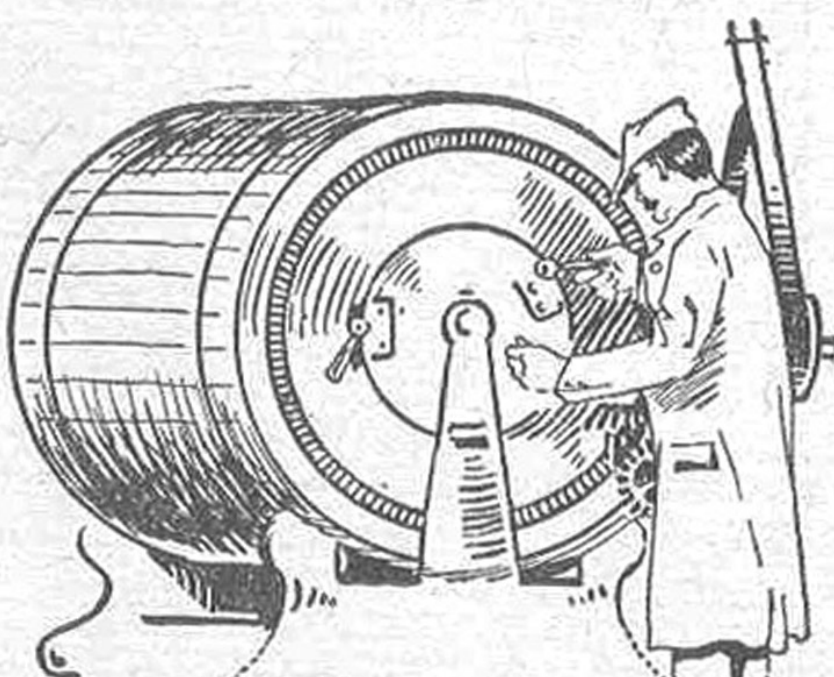

This is most important - Use

Windsor
Dairy
Made in
Canada **Salt**

THE CANADIAN SALT CO, LIMITED

253

This advertisement for a salt manufacturer focuses on the use of salt in the preparation of butter.

Source: *Nor'-west Farmer*, 5 March 1919, p.34

In spite of Mrs. Coates' success, many storekeepers found themselves holding lots of butter that were poorly prepared, or made with cream that had been spoiled by the Frenchweed the cows had consumed. Educational pamphlets were produced by agricultural colleges instructing farm wives how to produce high quality butter. They were advised to cool the cream immediately after separating and then return it to 54-64 degrees for several hours before churning. Successful churning was affected by several factors: temperature of the cream; the amount of butterfat content (apparently hard butter fats in winter were harder to unite); amount of cream in churn (1/3 full was best); speed (not too fast, which increases the time needed to unite fat globules, and not too slow, which injures the grains of butter); abnormal fermentations (which would lead to slimy or ropey cream, which was impossible to churn).²¹⁸ Once the churning was completed, the butter had to be washed carefully, salt added, and the butter paddled to remove the excess moisture. Then it was printed, wrapped in parchment paper, and packed in wooden boxes. These often gave the butter a bad flavour unless they were treated with a salt brine. With all these factors affecting the quality of homemade butter, the need for a creamery, where the quality of the butter could be closely monitored, became evident. Shipping cream to a creamery for processing was both less laborious and more cost effective.

The idea of having a creamery in every district was promoted by the Dominion Dairy Commission, which endeavoured to establish creameries all along the route of the newly completed Canadian Pacific Railway. Professor Robertson, of the Commission, proposed that the government erect the buildings and rent them to farmers at a low rate of interest. With his travelling dairy exhibit, in 1894 he visited points all along the railway, offering practical instructions on how to make butter and how to improve pasturage conditions. Local Farmers' Institutes studied the suggestion and realized that grants were needed to start such an enterprise. They recognized the need for a creamery, to improve the grades of their homemade butter, and the increase in prices that this would bring. As more land was developed in a region, more cream was being shipped out of local communities to be processed elsewhere. Local farmers came to see the value in forming a creamery company so these profits could stay in their district. The Manitoba Dairy Association proposed that the government offer a "Dollar for Dollar" grant towards the erection of new creameries. Instead, the government decided to offer a loan of \$500 towards the building of any new creamery or cheese plant.²¹⁹ While only 12 creameries had been built to that time, 14 opened in the next two years, as many communities took advantage of the grants. By 1914, the number of creameries had grown to 36.²²⁰

S.M. Barre, one of the early creamery operators in Manitoba, saw the proliferation of small creameries as a disadvantage. He pointed out that 18 local creameries produced only 650,000 pounds (295,454 kg) of butter in 1901, as compared to a 850,000 pound (386,363 kg) output by three larger central creameries.²²¹ The introduction of a flat rate on shipping cream in Manitoba, in 1898, had made it possible to ship cream to these larger processing plants; it cost only 20 cents to ship a can 150 miles, and 25 cents to ship it 250 miles. Unfortunately these rates were changed in 1902. A cream can then cost 20 cents to go 25 miles, and 44 cents to ship 100 miles.²²² Hence, the trend to more centralized processing plants was checked, and the local creameries prevailed, often operating with out-of-date equipment, on a summer basis only.

PARCHMENT BUTTER WRAPS

ONLY \$1.00 FOR 500—SPECIAL BARGAIN
 The most profitable way for farmers and their wives to market dairy butter is in one pound prints, each print wrapped in parchment paper. The new Dominion dairy law makes it a punishable offence to wrap these prints in parchment paper unless the paper is branded "Dairy Butter." You must not use plain parchment paper any more. This is to protect the public. You may have as much wording printed on your wrappers as you wish, but you must have at least these two words: "Dairy Butter." We have a large quantity of parchment butter wraps printed in two colors (red and blue), in brine-proof ink. The imprint on these wraps is as follows:

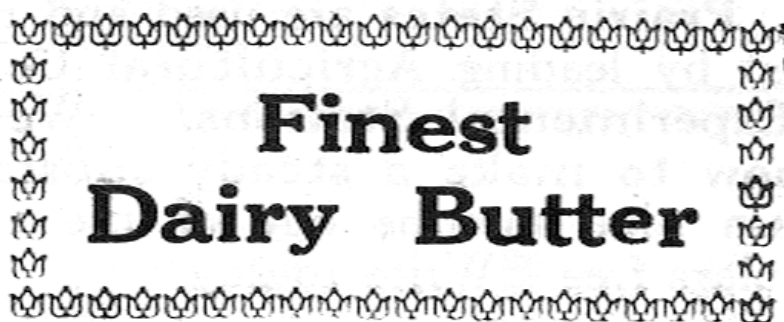

These two-color wraps will give your butter a very attractive appearance and bring the highest price. We can supply these wraps by return mail at the following prices post paid:—
In lots of 500:—Man., \$1.00; Sask., \$1.05; Alta., \$1.10.

No change can be made in the wording in any way at this price. These wraps are printed in large quantities, which accounts for the low price. We are reducing the price to less than cost to clean out a few that are left.

Butter wrapped in parchment paper was a more attractive method of presentation used by farm women, who commonly sold their homemade butter to the local grocer, who in turn sold it to urban dwellers.

Source: *Grain Growers Guide*, 9 February, 1919, p.10



Fisher Branch Creamery, in 1936 - The style of the structure is representative of the many small creameries built in Manitoba villages in the first half of the 20th Century.
Source: PAM, Malofie Collection

Farmers in remote areas that lacked creameries, especially along Lake Manitoba, used the transportation methods at hand to get their product to market. Cream boats operated on Lake Manitoba, beginning in spring 1915, bringing cream from isolated settlements around the Narrows, Crane River and Steeprock, where grazing land was available for cattle raising. Once a week, the cream boats stopped at designated landings and picked up the cream from the rancher to deliver it to the nearest train station, further south on the lake. Often, the boat operator received a list of supplies the rancher wanted purchased at the store for the return trip. The cream was shipped in three, five or ten-gallon (11, 18, or 38-litre) cans and the load usually consisted of 50 cans.²²³ Boats with names such as the "Reykjavik" indicated the Icelandic heritage of the boat operators and most of the cream shippers. Between 1911-1938, six different boats operated on Lake Manitoba, collecting cream and returning with supplies for the settlers.²²⁴ After 1931, cream could be taken to Ste. Rose Creamery by truck, and the cream boats fell into disuse.

With the building of numerous branch lines in the early 20th century, most farmers could ship their cream and milk by railway, depending on the schedules. Some farmers took their product to alternate stations, depending on where the train would be stopping on a specific day. Others brought their cream to the station after the evening milking, leaving it for early morning pick-up. In Manitoba's cold weather, there was always a chance the product would freeze rather than spoil. To prevent this, the Canadian Northern Railway required that their agents "use a canvas tarpaulin to cover the milk cans and in the centre of a group of cans place a coal oil lantern for heat".²²⁵

Until 1914, the amount of butter produced on dairies was more than double the amount produced in creameries. In 1904, for example, 1,067,243 pounds (485,110 kg) were produced in creameries, while 2,881,351 pounds (1,309,705 kg) were created in home dairies. The creamery butter sold on the average for 19 cents per pound (42 cents per kg), while the farm butter sold, on average, for 16 cents (35 cents per kg), an indication that it was more profitable for the farmer to produce and market his own product.²²⁶ The world war changed that, as farms suffered a labour shortage and as huge amounts of dairy products were required for overseas export, making mass production more profitable and efficient. In 1916, the Dairy Commissioner of Saskatchewan shipped a shipment of butter from Manitoba, Saskatchewan and Alberta directly to Manchester, England. It was hoped that this would lead to future trade. The Dairy Commissioner had therefore been careful to choose only No.1 creamery butter from each province to include in the shipment. The response was very positive from the English firm which received it:

In reference to the quality, we must congratulate you on all butters. They are certainly the finest parcel we have received from Canada, and if the three provinces maintain this quality, there is no doubt but that your butter will command very high prices on the British markets.²²⁷

The most important function of a creamery was to transform cream into butter. Originally, creameries were equipped with wooden churns, which turned counter clockwise, powered by a gas motor. The churn was made of cedar and had a window at the end to allow the butter maker to check the progress of the procedure. Pressure was released from the churn by a small valve before the churn was opened. After churning, the machine was rinsed with hot water and occasionally given a rock salt treatment to keep the wood from softening from its contact with the butter. At regular intervals, someone was required to crawl into the churn to give it a good scrubbing.

TWO HOUSEHOLD "FAVORITES"

FAVORITE



In 8 sizes, churns $\frac{1}{2}$ to 30 gallons cream. Patent foot and lever drive. Roller bearings. Steel frame. Easy to operate. Superior in workmanship and finish.
Sold by all leading jobbers. If you cannot procure, write us direct.

PURITAN
REACTING
WASHING
MACHINE.



ROLLER BEARING RUNS EASY.

Latest and most improved. Tell your jobber you want it. Don't accept any substitute. Beautifully finished in Grained Oak, Royal Blue or Wine Color and Silver Aluminum. Write direct to us.

DAVID MAXWELL & SONS, ST. MARY'S, ONTARIO.

An advertisement for a butter churn - The size of the machine limited its practicality to farms with many dairy cattle.

Source: *Western Home Monthly*, November 1907 p.47

CREAM WANTED!

We pay Highest Cash Prices for all kinds of CREAM, and pay Express Charges also. Write at once.

MANITOBA CREAMERY CO. Ltd.
509 William Ave., Winnipeg



New Wonder-Worker Makes Butter in 3 to 5 Minutes

Finest granular creamery butter, from *sweet* as well as *sour* milk or cream—with just a few twists of the wrist. Try it—at our risk—you'll be astounded. The New

KING Ball-Bearing Separator and Aerator

is the most sensational dairy invention in years. New scientific principle; entirely different from churning. Gets 20 to 33 per cent more butter; extra profit soon pays its cost.

Try it 10 Days FREE!

You'll never again use mussy, smelly, wasteful, back-breaking churns. The King has sanitary milk vessel; no wood, no cracks or corners to hold grease or dirt. A 10-year-old child can operate it. 3 sizes, \$5 up. Send for circular, etc.

\$150 a Month to Agents

also expenses. Salary or commission. Every cow-owner needs a King. Write at once for *free sample* and salary proposition.

DeKing Mfg. Co., Dept. L3, Chicago, Ill.

Advertisement for cream shippers to send cream to a Winnipeg creamery - Also an advertisement for a home butter churn. This particular model didn't become a popular choice for Manitoba farmers.

Source: *Grain Growers Guide*, 21 April 1915, p.22

When the butter maker judged that the churning process was completed, he pressed the valve to release the pressure, then drained the buttermilk, added some salt and, in winter, some colour, to bring the butter to a more natural summer colour. The humidity of the butter was then tested and the water content was adjusted to bring it up to required standards for moisture content.

With so many factories preparing butter for market, it was important that some system of preserving quality had to be established. The first group to deal with the problem was a committee of retailers and producers in the Virden district.²²⁸ In 1890, they came up with a set of recommendations for grading butter, and establishing prices for the various types of product. These included:

1. That a public inspector be appointed in each town and that he be paid by the purchaser.
2. That the butter shall have classes - Number 1, 2 and 3. The prices shall be Number 2, three cents below Number 1; Number 3, four cents below Number 2.
3. That the butter must be packed in new tubs, which should be painted with paraffin on the inside. No old pails or tubs to be used.
4. That butter in rolls for immediate use also be graded, and paid according to quality.
5. That the price paid will be regulated by the Winnipeg market.
6. That English dairy salt shall be used.²²⁹

These recommendations were not adopted provincially. In 1899, it was made compulsory for all creamery butter to be packaged in squares.²³⁰ It was not until 1914 that the Manitoba Department of Agriculture took responsibility for grading butter in the province and appointed L.A. Gibson as the first butter grader. That same year, at a Manitoba Dairy Convention, a committee considered standards for cream grading. Finally, in 1923, the Manitoba Government established cream grades and standards and appointed government graders to visit creameries. The following set of standards was established:

1. Table Cream - sweet, clean-flavoured, non-frozen, for household use, with .002% acidity.
2. Special Grade - clean, uniform consistency, suitable for butter making, with .003% acidity.
3. First Grade - reasonably clean, uniform consistency and suitable for butter making, acidity at .006%.
4. Second Grade - cream that does not meet above standards: bitter, stale, musty, metallic or otherwise unclean.
5. Off Grade - cream with objectionable flavour or odour such as kerosene, gasoline, stinkweed, onions, etc. making it unsuitable for Number Two butter.

A price ratio of two cents was set between the first two grades, and three cents between the second two grades.²³¹

In 1915, Manitoba exported 35 cars of butter to Ontario and 18 cars to British Columbia.²³² It was essential that the quality of that butter be kept high. As a result of the institution of cream grading, the quality of cream did greatly improve. In 1923, most cream graded as No. 1 but 21.8% still classified as No. 2. By 1934, the percentage classified as No. 2 had dropped to 3.4, and the greatest percentage of cream (68.7%) now classified as Table Cream.²³³ Butter competitions helped Manitoba establish a reputation for butter quality and were important in benefitting all Manitoba creameries. In the 1920s, the Shoal Lake creamery consistently came first in these competitions.²³⁴ In the 1950s, the Smellie chain of creameries in the Parkland region won many of the national and international awards for butter.

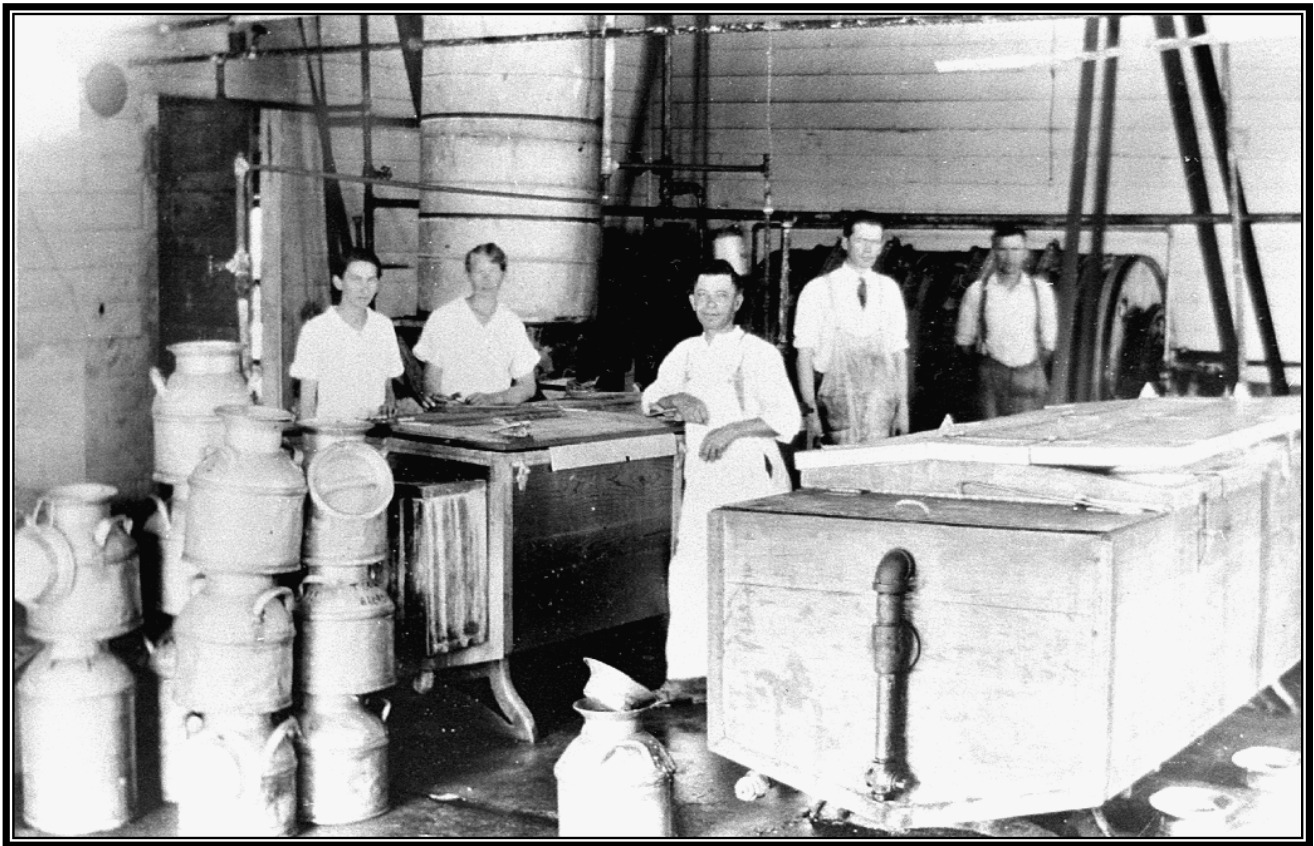

Inside Fisher Branch Creamery, showing butter churn behind, and cream vats.
Source: PAM, Malofie Collection

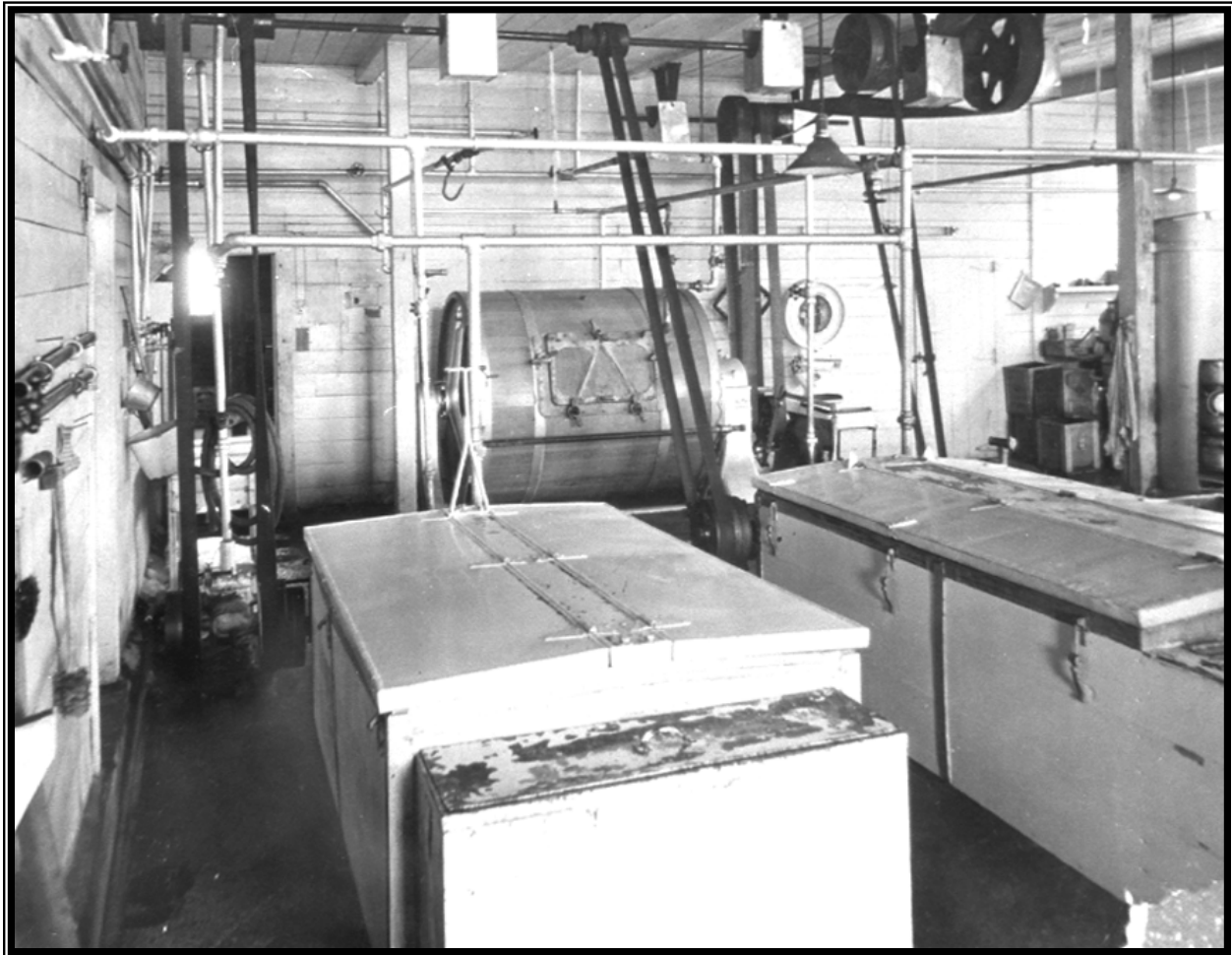

Another view of the interior of the Fisher Branch Creamery, showing the cream vats and butter churn.

Source: PAM, Malofie Collection

In the period around the World War I, the number of creameries grew, until by 1920 there were 41 operating, with a combined output of over seven million pounds (3,181,818 kg) of butter annually.²³⁵ Many of the small creameries started in this period functioned for only a few years before being absorbed by a chain or closing. There were also cream-buying stations at local stores where the cream was collected for shipping by rail to a creamery. Often, the milk kept at these points went unrefrigerated, lowering the quality. In 1921, cream-buying stations were closed by the new legislation that required milk to be inspected and cream tested. Since the people in Great Britain found Manitoba butter too salted, in 1924 the first unsalted butter was shipped to Britain. That same year, yeast and mould counts were made on commercial churnings of butter. In 1925, a corrugated roller was first used for finishing the surface of commercial butter.²³⁶

Not all creameries were beneficial to a community, as witnessed by a complaint brought before the Minister of Agriculture, V. Winkler in 1919.

We are having considerable trouble with the Crescent Creamery. They run their wash water out in the open drain and the people around can hardly live and apparently they will do nothing to make it sanitary. ...We have had our health officer give them orders to close but the man who is running the plant says to hell with the people.²³⁷

Winkler's reply was "This is altogether up to the health Officer, who can certainly stop them doing so."²³⁸ In fact, Dairy Commissioner, J.A. Ruddick, had tried to impress upon creamery operators the importance of having a good water supply, as well as an efficient drainage system, that would prevent just the contamination this community was experiencing.²³⁹

These small creameries were essential, however, to farming communities. The account books of a farmer (Freeman Lowe) in the Belmont area, demonstrated that the cream he took to the Belmont creamery accounted for the majority of his cash income in 1940. Mr. Lowe was a mixed farmer who was raising grain and pigs. His few Holstein cattle, milked twice a day by hand, were a real benefit to the family. In the heat of the drought of 1936-7, when he had trouble keeping his cream from spoiling before he could get it to the creamery, the Dairy Commissioner, L.A. Gibson, to whom the Department of Agriculture referred him, offered practical advice.²⁴⁰

In the 1920s, the number of creameries dropped from 16 to 21.²⁴¹ Not surprisingly, the number jumped to 90 during the Second World War.²⁴² The greatest number of these was in the electoral district of Provencher, which encompassed eastern Manitoba, and in the Winnipeg to Selkirk region. In that year, the creameries accepted 170,505,121 pounds (10,456,653 kg) of milk and 23,004,637 pounds (7,750,232 kg) of cream. Of this, over 75 million pounds (34,090,909 kg) were taken in by the creameries in the Provencher-Winnipeg area, indicating the growing population of the city. The greatest proportion of the cream was also shipped to creameries in that region.²⁴³



In the 1950s, many of the small independent creameries, such as this facility in Chatfield, were purchased by larger firms such as the Manitoba Co-operative Creamery.
Source: PAM, Poplarfield Col. NC, CH-008

The decline in shipment of farm separated cream, which began in the 1950s, was most evident in the period between 1970 and 1985, when the number of farmers doing so dropped from 8,919 to 1,855. In this same period, the number of farms shipping fluid milk doubled, as farmers made the choice to either mechanize and become major dairy farms, or to give up dairy cattle all together. The reduction in shippers corresponded to a reduction in creameries.²⁴⁴ The decision these farmers made resulted in an incredible increase in the cash receipts from dairying, as Manitoba's net receipts from dairying rose from \$63,419,000 in 1979 to \$104,926,000 in 1984.²⁴⁵

Today, butter is made in large plants from pasteurized, separated, fresh cream, with 30-40% butterfat. It is mechanically churned, usually in a rotating cylinder, for approximately 45 minutes. The butter is washed and worked into a soft mass, then graded, measured and packaged in parchment, or parchment-lined tinfoil. The butter is then sold by the processor to supermarkets etc. who may choose to market it under their own labels.²⁴⁶

PROMOTION OF DAIRY EDUCATION

In an effort to promote dairying, in 1886 the provincial government hired Professor S.M. Barre to travel around Manitoba lecturing on dairying. He held fifteen meetings across the province before becoming a dairy processor and merchandiser. In 1893, he opened an office in Winnipeg with cold storage facilities, and began shipping Manitoba cheese to Great Britain. He was the first person to start paying for cream on the basis of the Babcock test. He advocated creamery centralization, and pasteurization.

DAIRY SCHOOL

The first Dairy School was opened in Winnipeg in the Bullman Block on Bannatyne Avenue in January 1896. The school had four instructors, teaching courses on milk testing, cheese making, butter making and engineering. That year, 97 students took the course, while another 12 wrote the standardized examinations to establish their credentials as butter and cheese makers. In its second year, the School moved to the Henderson Block in Market Square and had an enrolment of 64 students, 42 of whom were daughters of farmers. That year, the school sent speakers to tour the Mennonite areas of the province to hold informational dairy meetings. This became a standard routine, with professors, and those involved in the dairy industry, offering their expertise to farmers.

In its third year of operation, the school moved to Thistle Street, and in its new quarters installed a Lister pasteurizer for experimental and teaching purposes. Thus began a new purpose for the dairy school - not only to inform dairy farmers, but also to undertake research to improve the industry. In April 1898, the Dairy School held cheese-making workshops in St. Pierre and Steinbach.

Not only did the Dairy School continue to offer instruction in Winnipeg for farmers, it decided to spread dairy education throughout the province by launching special dairy trains. Assisted by the Ministry of Agriculture, local agricultural societies and the railway companies, the first dairy train was equipped with a refrigerator car, and a passenger coach filled with dairy equipment, sufficient to offer lectures and demonstrations at points along the railway. In 1907, the Manitoba Department of Agriculture ran the first dairy specialty train through the province on the Canadian Northern Railway, headed for Swan River. The dairy trains were so successful that the Department of Agriculture began to enlarge them to include other lines of agriculture. Until 1923, a special dairy car was always included in the Better Farming Trains.

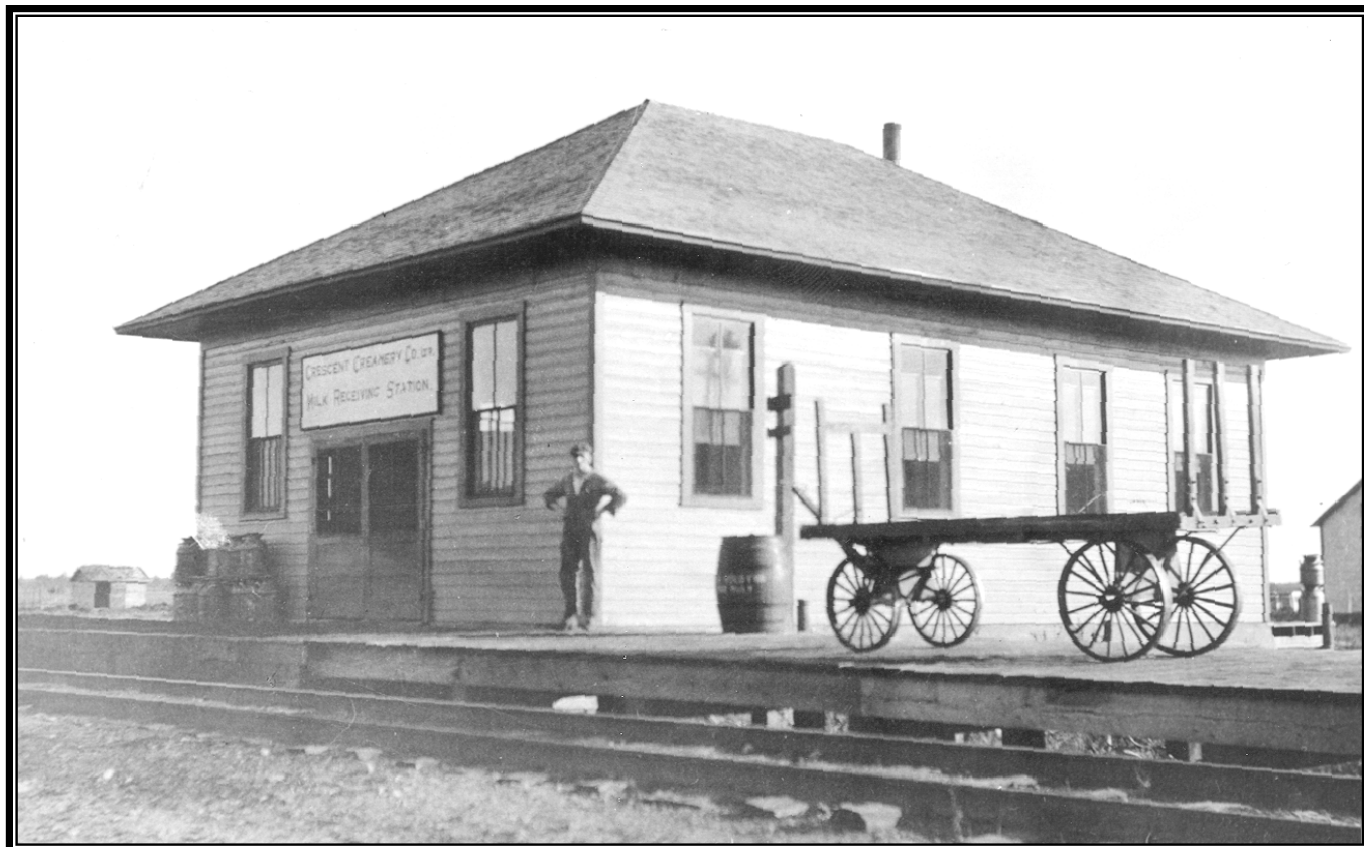

In villages where milk production was high, creameries sometimes established shipping stations with proper storage facilities for the fresh milk and cream delivered there by area farmers. This is the Crescent Creamery Co.'s milk receiving station at Giroux, in southeastern Manitoba, in 1915.
Source: PAM, Giroux, N19261

In 1905, the Roblin Government announced that there would be a Manitoba Agricultural College established in Winnipeg. It opened in 1906 in the suburb of Tuxedo, with J.W. Carson as professor of Dairying and also as Dairy Commissioner. The first class, of 10-weeks duration, actually opened in February 1906 before the campus was completed. In fall 1906, when the College officially opened, there were 28 students enrolled in the eight-week course. They were taught cheese-making, butter making, milk testing, dairy chemistry, dairy bacteriology and judging of dairy cattle. In 1911, the Agricultural College moved to a new larger campus south of Winnipeg, where it was later combined to form the University of Manitoba campus. The Dairy Department became the Department of Food Science in 1967.

In its early years, the dairy course consisted largely of farm work with students, who were usually returning to careers as farmers, gaining hands-on experience while working with cattle. Two essential principles were stressed at the school: economy of production and improvement of product quality. The three-month dairy factory course, which lapsed for ten years but was reinstated in 1919, turned out trained personnel to operate the dairy plants all over the province. A creamery was established on the campus in 1922 and this plant provided the dairy products used by the university well into the 1980s.

Dairy research activities at the university can be traced back to 1920. They covered a range of topics, such as colour and texture of butter and the preparation of dairy spreads. Grants to carry out research by post-graduate students and professors were received from the federal government. The dairy plant at the University played a key role in research because it was well-equipped to demonstrate butter making, cheese-making, ice cream manufacture, as well as the processing of cream and milk. The equipment at the plant was kept up to date. Prior to 1950, a dairy herd was also kept at the University to use for teaching purposes and demonstrations of management purposes. Later, the herd was moved off campus, south to Glenlea, but research continued on nutrition of dairy calves and lactating dairy cows. Cross-breeding studies were undertaken to improve cattle for Manitoba's climate. Major studies were undertaken on performance of cows in stanchion barns, loose housing and free stall systems.²⁴⁷

4-H CLUBS

Since 1913, members of 4-H clubs across Manitoba and Canada have pledged to use their heads, hearts, hands, and health for the betterment of their clubs, communities and country. Known as the Boys and Girls Clubs until 1952, 4-H had its beginnings in Roland, Manitoba. Dedicated to the principle of "learning to do by doing," the first clubs were organized to promote agricultural progress through the education of rural children. In addition to learning about everything from canning and sewing to grain farming and livestock raising, members were encouraged to work together toward common goals. The clubs promoted leadership skills, co-operation and a strong sense of community spirit.²⁴⁸

The 4-H program was used to educate children in the care of dairy cattle. Each club member was given a newly born calf and required to care for it for one year. The experience taught the members the rudiments of raising dairy calves, such as feeding, keeping calves clean, training the calf to lead, and techniques for showing a calf at a fair. They learned the 34 parts of a dairy cow and how to judge calves, using a scorecard. The highlight of a calf club member's year was showing his/her calf at the local fair.

The clubs were popular because there were many field trips. One thing the children did was visit each other's homes to see the calves. There were achievement days and rallies and trips

to fairs. A win at a local fair meant advancement to a fair at a higher level, such as the Brandon Winter fair, or the Royal Agricultural Winter Fair in Toronto.

The area around Steinbach was particularly strong in Calf clubs and at the first annual Hanover Agricultural Fair in 1946, there were nine calf clubs represented. Southeastern dairy calf clubs won top honours at the Kiwanis Dairy Calf Show in Winnipeg that year. One club, at Grunthal, was the largest calf club in the province.

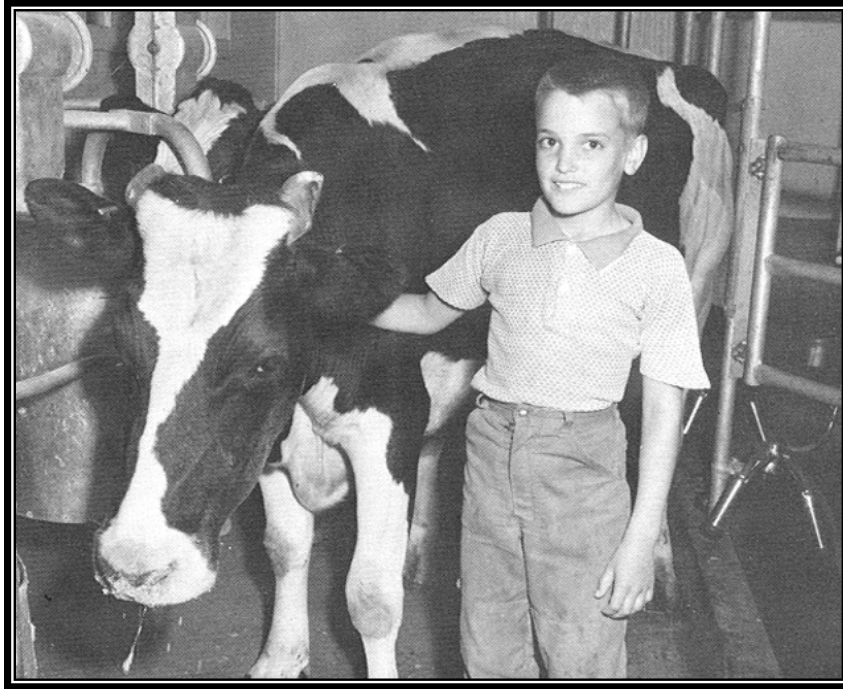

A 4-H Dairy Club member with his prize-winning calf
Source: Linda Penner, *Hanover: One Hundred Years*, p.73

LIVESTOCK SHOWS

Exhibitions, backed by the Department of Agriculture, such as the Brandon summer fair, first held in 1889, and the Brandon Winter Fair, first held in December 1884, were designed to highlight agricultural excellence and improve farm and cattle-raising standards. By 1912, the Brandon Winter Fair had established itself as Manitoba's premier livestock show and winter agricultural education event.²⁴⁹ At some fairs as many as 2000 4-H members were in attendance, exhibiting their calves, and learning agricultural techniques that they would use in their future careers as farmers.²⁵⁰ The largest annual exhibition of Holstein cattle in Manitoba was at the Brandon fair in the 1940s. Today, the Brandon Winter Fair, now known as the Royal Manitoba Winter Fair, remains one of the premier agricultural exhibitions in Canada.

Smaller local fairs also offered a great opportunity to highlight the importance of breeding high quality livestock. Most fairs had various categories for exhibiting cattle and it was a source of pride to have one's animals win the prizes. As early as the 1930s, the St. Claude fair was recognized as an important forum for exhibiting high quality Holstein cattle, second only to the Brandon.. Most of the farmers in the region raised ROP herds and competition was keen.

DAIRY ORGANIZATIONS

MANITOBA DAIRY ASSOCIATION

In April 1886, following the passage of *The Manitoba Dairy Act*, meetings were held by dairymen to discuss the formation of an association. The Manitoba Dairy Association was officially incorporated on July 14, 1886 by an Act of the Legislature.²⁵¹ The organization's purpose was to promote the growth of the industry and to act as a lobby for much needed legislation to set industry standards. The first meeting of the organization was held on July 14, 1886, with William Wagner as chair. He subsequently was elected as the first president. Members were elected by mail and the board members came from all parts of Manitoba. Beginning in 1894, the Department of Agriculture gave annual grants to the association. An annual convention, held during the winter, provided a meeting place for producers, processors and consumers. In 1910, the association successfully lobbied before the Railway Commission for relief in transportation rates, inaugurating its role as a spokesman for dairy farmers across the province. The association also sponsored cream and butter competitions and dairy exhibits at fairs. They even chose a Dairy Maid to compete for the crown of Dairy Princess at the Canadian National Exhibition in 1960.

MANITOBA MILK PRODUCERS CO-OP INC.

In 1923, the first Milk Producers Co-op was formed in Winnipeg district. In April 1974, other Milk Producers' organizations, which existed in Dauphin and Brandon districts, combined with the Winnipeg region to become the Manitoba Milk Producers Co-op Inc. The organization was divided into nine districts, each with a director. In 1990, the Co-op ceased operations and its function came under the Manitoba Milk Producers Marketing Board.²⁵²

MANITOBA CO-OPERATIVE CHEESE PRODUCERS ASSOCIATION

In 1940-41, all cheese factories in Manitoba were organized to sell cheese co-operatively. The co-operative, working out of Winnipeg, sold cheese to Kraft's, Canada Packers, and Swifts, at a price generally set in Eastern Canada. The Co-operative Association gave the small cheese factories in Manitoba some marketing clout, and kept the independents from being put out of business.

MANITOBA BUTTERMAKERS ASSOCIATION

Formed in 1925, with J. McLean of Eaton's Creamery as its first president, this organization merged with the Manitoba Technologists Association in 1970. The butter makers' membership included creamery managers, licensed butter makers and dairy instructors. They sponsored annual meetings and worked closely with the Dairy Branch to organize butter competitions.

DAIRY MANUFACTURERS ASSOCIATION

Formed in 1917, with Alex McKay as first president, this group helped finance dairy conventions by levelling a yearly assessment on each plant. In 1941, this group merged with the Manitoba Dairy Association via an agreement that gave the presidency of that organization alternately between a producer and a processor.

THE DAIRY CATTLE BREEDERS ASSOCIATION

Formed in 1926, with G.W. Tovell as first president, this group held annual meetings in conjunction with the Dairy Convention before becoming part of the Dairy Farmers of Canada.

NATIONAL DAIRY COUNCIL

Although a national, rather than a Manitoba-based, organization, the policies of this organization affected Manitoba dairymen. Several Manitobans, such as R.C. Smellie, Wood K. St. John and J.G. Speirs were prominent members of the organization. Formed in 1918, to work with federal civil servants administering dairy legislation, the organization was split between dairy producers and dairy processors in 1936. The producers formed their own organization, the Canadian Federation of Dairy Farmers. The association joined with The Dairy Cattle Breeders' Association to form the Dairy Farmers of Canada. The National Dairy Council survived, and over the years has maintained a close alliance with provincial dairy branches and with the national Dairy Farmers of Canada.

WINNIPEG DISTRICT MILK PRODUCERS CO-OPERATIVE ASSOCIATION LIMITED

This organization was formed in 1923, by Wm. Elliot of Stonewall and G.W. Tovell of Dugald, who persuaded various groups of producers that they needed protection against the tactics of the distributors, who were covering winter milk shortages by persuading cream producers to ship milk at full quota prices. Many producers were reluctant to join the Co-operative, fearing reaction from the distributors. An agreement was worked out with City Dairy to have membership deducted from milk cheques, in return for encouraging producers to ship their cream to City Dairy. This system broke down in 1928, over a dispute over milk prices. The organization limped along until the Milk Board stepped in and authorized the deduction of membership fees from those producers who were members of the Association. During the Second World War, the Association waged a dispute over the price paid producers for their milk. This issue was not resolved until 1951, when Premier Douglas Campbell ordered a legislative inquiry into milk prices and the control of the Milk Control Board. This resulted in new legislation that set a maximum on consumer prices and a minimum on producer prices, and set other regulations which applied to not only the Winnipeg area, but to all the other fluid milk markets in Manitoba. After 1951, the history of the Association was less tumultuous and in 1974, the organization became the Manitoba Milk Producers' Co-operative Association Limited, uniting with other producer organizations in Portage, Brandon, Dauphin, Winkler, and Souris.

MANITOBA MILK PRODUCERS MARKETING BOARD

This organization's history is closely tied to the Winnipeg District Milk Producers' Co-operative Association. The main purpose of both organizations was to protect and improve the position of dairy farmers, i.e. the producers. Between 1923 and 1951, the latter organization worked to insure that fluid milk producers in the Winnipeg area had enough bargaining power to allow them to make a decent living. Other cooperatives sprang up in other dairy-producing areas of the province, although two major areas, Grunthal and St. Claude, remained unorganized. Meanwhile, the Milk Control Board of Manitoba was established in 1937, with the mandate to control the fluid milk industry in Manitoba. This Board represented the interests of the consumers while the various co-operatives represented the interests of the producers.

To form a more powerful umbrella organization for all the regional co-operatives, the Dairy Farmers of Manitoba organized a series of meetings for interested producers. From these well-

attended meetings, the Manitoba Industrial Milk Producers Association was formed in 1973. Changing conditions in the milk industry made it feasible to form a combined board. Besides a shortage of milk in the fluid market and an expanding subsidy program by the Canadian Dairy Commission, it was apparent that greater government control would be introduced and it was desirable that producers be part of that process. An agreement was worked out whereby a board of nine members would be appointed from lists submitted by the producer organizations. On October 1, 1974, the Manitoba Milk Producers' Marketing Board assumed all responsibility for marketing fluid milk to processors in Manitoba, including the operation of the pool, the payment to producers, the transporting of milk, and the administration of the Market Share Quota program. The Board has the responsibility for purchasing all milk in Manitoba. The Milk Control Board has first call on all available supplies of Class 1 milk and determines the price of it. The Board arranges for the delivery of all milk to processing plants and pools all the money received for it, which is determined by the usage to which the milk is put (bottled, skim milk powder, ice cream, cheeses). From the money collected, the marketing costs are deducted and the balance is paid out to producers according to the quality and quantity of milk they have shipped.

DAIRY FARMERS OF MANITOBA

This association was formed at the National Dairy Convention in 1959. The association encompassed a number of local producer organizations. Its aim was: to provide a forum for the discussion of problems connected with the production and sale of dairy products; to become members and supporters of the Dairy Farmers of Canada; to represent and speak for dairy farmers in Manitoba on matters with provincial jurisdiction; to protect and encourage the production and sale of dairy products in Manitoba; and to cooperate with the Dairy Manufacturers' Association.²⁵³

DAIRY STRUCTURES

COWSHEDS

The cowshed is the home of the dairy cow, and the place that, in winter, the animal will live, eat, sleep and perform its natural functions, in addition to having to be milked in the same place year round. Because of Manitoba's winters this meant that a dairy cow could be in a stable for 150-200 days. Until the 1920s, not enough attention was paid to making this a hygienic place. Most often the cowshed was a dark, ill-ventilated, unsanitary place that was not conducive to healthy conditions for the cattle. It was easy for animals to infect one another under such conditions. In fact, the farmers themselves were also at risk of contracting tuberculosis from the cattle.

The first barns in Manitoba were probably of a lean-to nature, with straw or sod roofs, and housing all manner of farm animals. The second generation structure was likely of logs and often so well built that many lasted into the 1950s. Anglo-Ontarian settlers brought the idea of bank barns with them but, finding few banks into which to set them, began to build hip-roofed barns with lofts into which hay could be winched. These barns had wooden stalls, low ceilings, poor lighting, and, in most cases, wooden floors. A barn was often a symbol of the farmer's prosperity and might be a far more impressive structure than the farmer's house. Many of the huge barns built in the early 1900s, and well afterward, were constructed at "barn raisings", where all the neighbours came to supply the labour for the project. The barns, usually built in one day, were similar in that they were supported by a frame of large, squared beams, with mortise and tenon joints held together with wooden pegs. At barn raisings, because the same techniques were generally used, teams would each build one side, in competition with one

another to see who could finish first. The fitting of the beams would be done on the ground and then the components were hoisted into place. One example is the Eastview barn, near Argyle, which was built in 1906 for Sam Sims with a 90-man crew of neighbours. "By six o'clock the work was done and the barn is no small one, being 80 feet by 40 feet with 12-foot side posts on a nine-foot stone wall." [24m by 12 m with 3.6 m side posts].²⁵⁴

At the turn of the century, which marked the beginning of the improvement period in a farm's development, many farmers were reading articles about how to improve the quality of their dairy herds and this included advice on how to house them. The Chief of the Dairy Division of the Manitoba Health Department, in 1912, gave them the following advice:

The cow stable is the kitchen where the food for many city babies is prepared, and it is the duty of every farmer and dairyman to see that the kitchen is clean. Cow stables should be light and well ventilated, fitted with concrete floors and steel stalls which are practically indestructible and are necessary for the following reasons: Concrete floors do not soak up manure, which is one of the chief causes of the spread of tuberculosis in cattle.

Steel stanchions and stalls do not obstruct the light, are easily kept clean and do not soak up manure. Stables constructed in this manner are lighter, cleaner, and more comfortable for the cattle.²⁵⁵

Farmers began to construct barns with open centres into which modern elevating equipment could be placed. A cornice or a cupola on the barn served no purpose, added little to the cost, but improved its appearance. Some cupolas were filled with windows, which provided some light for the barn. One concept using this type of lighting was the round or octagonal barn. One of these, built in 1900 near Manitou by Henry Deamel, still stands today. It was built with a stone foundation, a forty-foot (12 m) roof, a 1200-bushel (32-litre) grain bin, a 300-bushel (8.25-litre) chop bin in the loft, and a cupola leading to a twenty-foot (6-metre) windmill, which was used to grind, feed and pump water. An earthen ramp provided access to the loft. Livestock was housed on the main floor in a circle facing the centre. There was an eight-foot (2.4-metre) clean-out alley behind them. "The concept of the circular barn was that it would withstand the pummelling prairie winds better than the more common rectangular buildings."²⁵⁶

A plank frame was stronger than the old fashioned frame made of large timbers. Since sunlight was considered a strong disinfectant, farmers were encouraged to put rows of windows, hinging inward, along the sides of the barn. Concrete floors were touted as the best. Instead of stalls the cattlemen were encouraged to use stanchions because they opened up the barn interior and were easier to keep clean. The swinging steel stanchion became the accepted way to tie up dairy cows for milking. Concrete mangers and gutters were advised. Litter carriers were installed that carried as much as 1000 pounds (454 kg) of manure in a load. A metal, overhead track allowed the farmer to mechanically move the manure through the barn to dump on a wagon or sleigh outside the barn. Similarly, an overhead feed carrier would allow one man to handle two tons (1814 kg) of feed for the cattle.

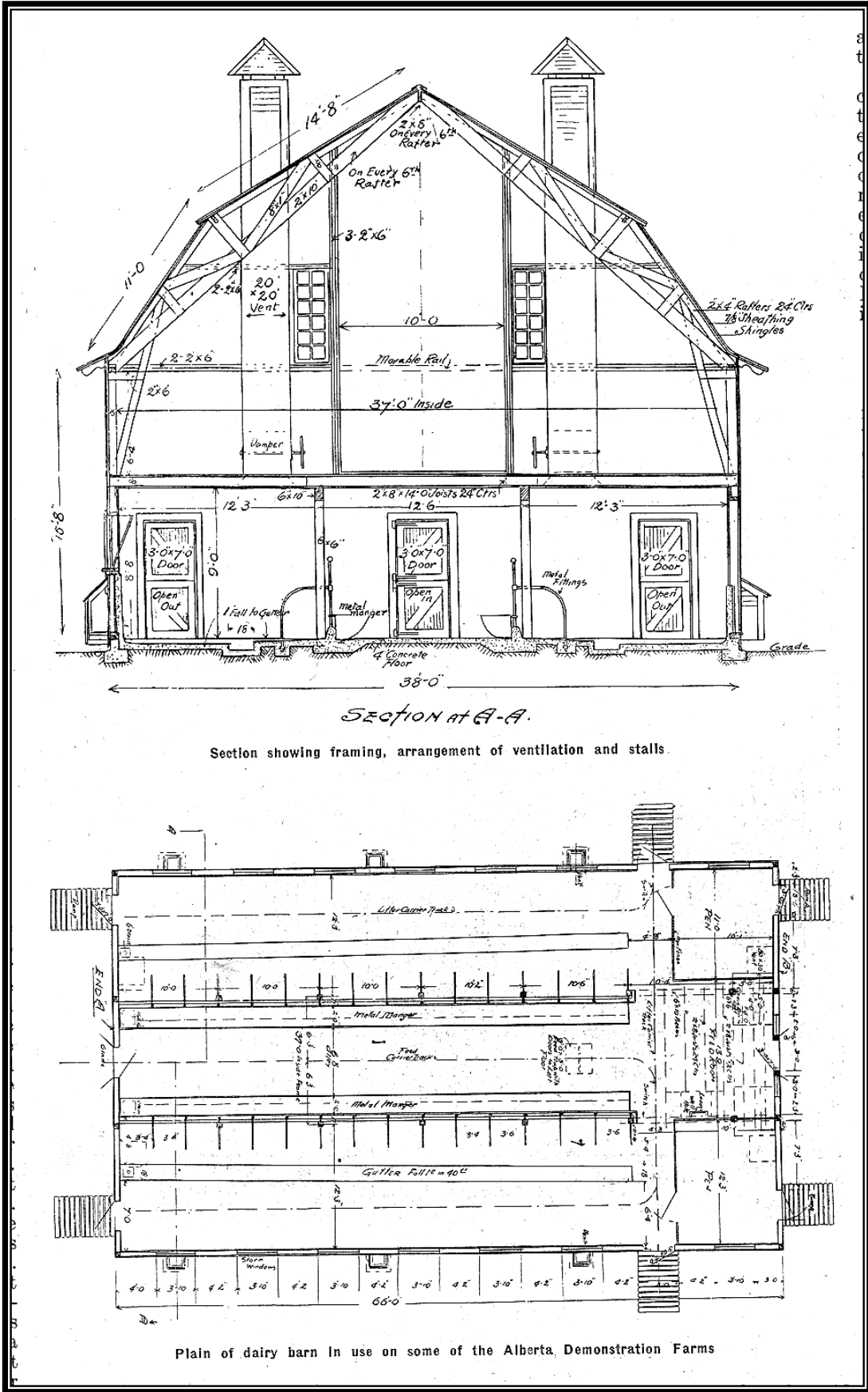

Plan for a standard dairy barn
 Source: Grain Growers Guide, 21 April 1915, p.9

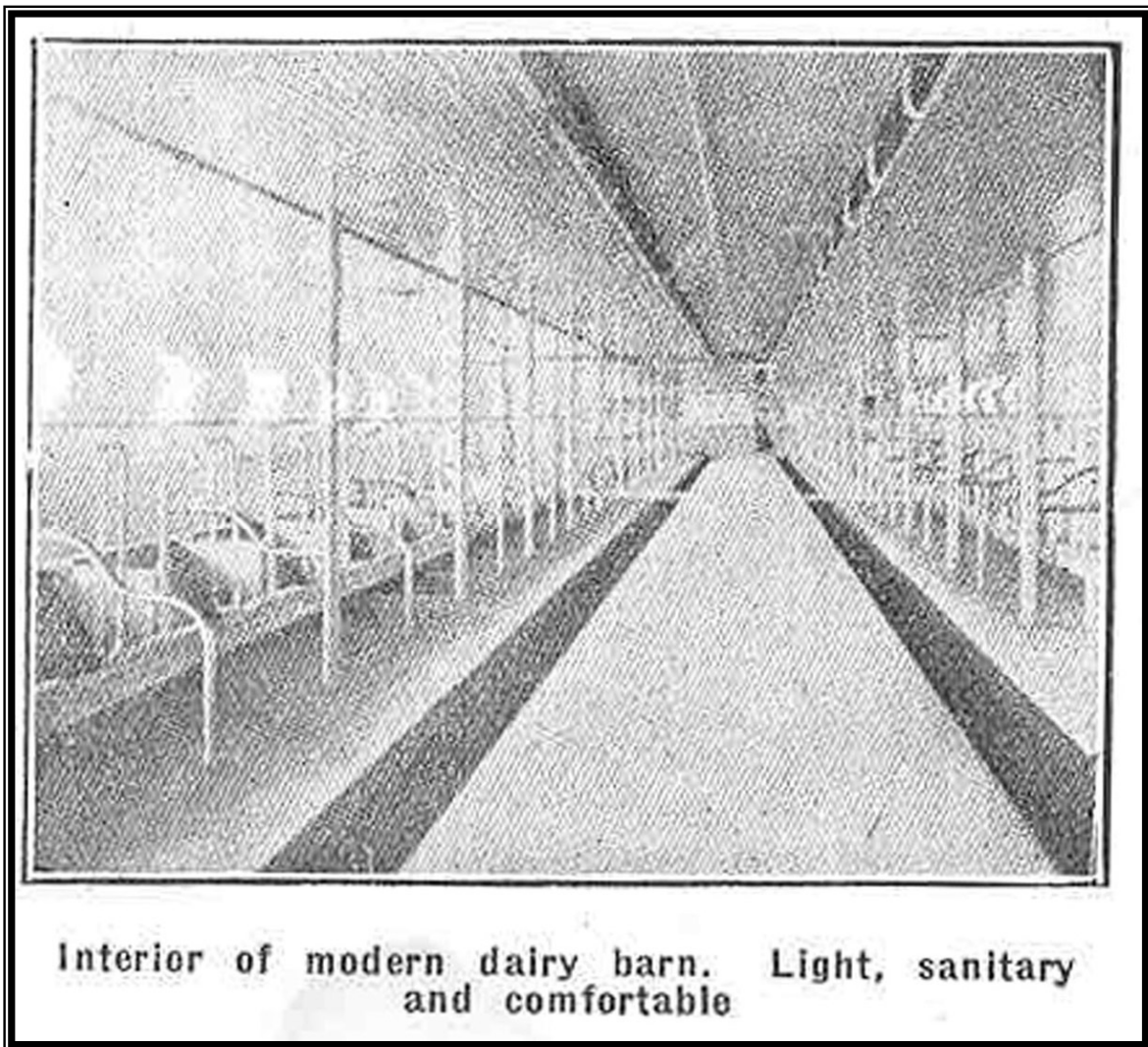

This barn from the 1915 period demonstrates a preference for steel stanchions over wooden stalls. Note the gutters for carrying away the manure.
Source: *Grain Growers Guide*, 21 April 1915, p.9

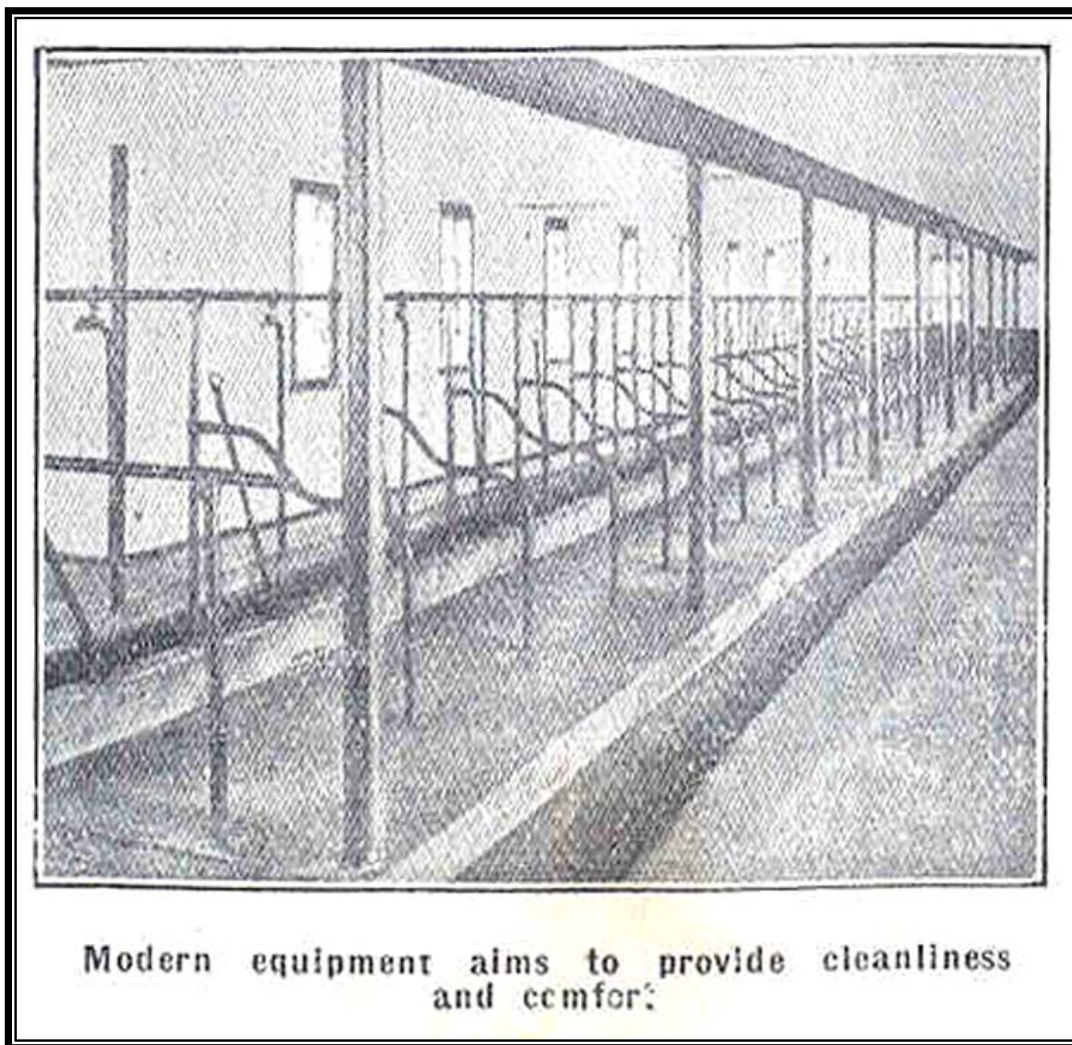

Modern equipment aims to provide cleanliness
and comfort.

The windows in this 1915 barn let in light. The openness created by using steel stanchions instead of wooden stalls gave a general appearance of more space. Source: *Grain Growers Guide*, 21 April 1915, p.9.

In the 1930s, farmers creating new dairy barns were given the following advice and suggestions for building a new milk shed. Two cardinal aspects in the construction of any cowshed are clean air and clean surroundings. There was to be a concerted effort made to replace the unsanitary conditions of old cowsheds with new cowsheds or barns that would reflect the following essentials:

- sound construction, with arrangements that eased the work load while providing comfort for the cattle,
- conditions that allowed the cows to keep themselves clean,
- minimization of the labour of feeding, watering, cleaning the animals,
- convenient food storage,
- adequate lighting and ventilation, and,
- ample water supply for drinking and cleaning purposes.

Single row cowsheds were deemed appropriate for smaller herds, becoming too long if intended to house a herd of more than 10-14 cows. Barns were therefore designed as double ranged, which meant the animals could either be arranged head-to-head, or tail-to-tail (See Figures 1 & 2). In the head-to-head arrangement, light was on the hindquarters of the cow, allowing the milker to work in good light. Feeding was also easier, since the animals could be fed from both sides of the feeding passage at one time. The cows could enter the barn and find their stalls with less confusion. The disadvantages of the head-to-head arrangement was the extra work entailed in removing the manure, and the fact that the walls could become splattered with manure. Also the animals breathed into each other's faces, making the spread of disease easier.

In barns arranged tail-to-tail, the cleaning and milking were centralized. The cows no longer breathed into each other's faces and manure no longer splattered the walls. However, this arrangement did entail extra work, and the lighting for milking was compromised. Either arrangement had advantages and disadvantages, leaving the choice resting on the particular view of the owner.

The stalls had to be long enough to ensure that the cow was not standing in the gutter where the dung was being deposited. The width of the stall had to be sufficient to prevent the animals standing on one another, but not so wide that they could turn their bodies sufficiently to deposit dung in the stall. It was important that the animals, when lying down, were not lying in their excrement, since this dirtied their udders and increased bacterial counts in milk. Bars or separations were placed between stalls, as a way of preventing too much sideways movement. Since different breeds of cattle came in different sizes, it was important that the stalls were designed with a particular breed in mind.

Passages behind or in front of the stalls had to be wide enough to facilitate milking, feeding, and cleaning. Four to six feet (1.2-2 m) would allow either a cart or a wheelbarrow to travel down the alley. Since good lighting was essential in a barn, it was advisable that double range sheds ran north to south and single range cowsheds ran west to east. Natural lighting might come from windows in a barn where cows were arranged head-to-head but roof lighting was advisable if they stood tail to tail. Sunlight was preferred over artificial light because it had bacterial-fighting properties. Lighting, provided by lamps in the pioneer period, was inadequate for clean milking.

Type 1.—Single range—accommodation for 10 cows with or without feeding passage, as desired.

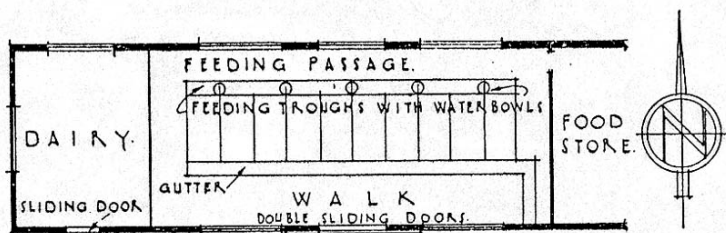

Type 2.—Double range—head to head—accommodation for 32 COWS.

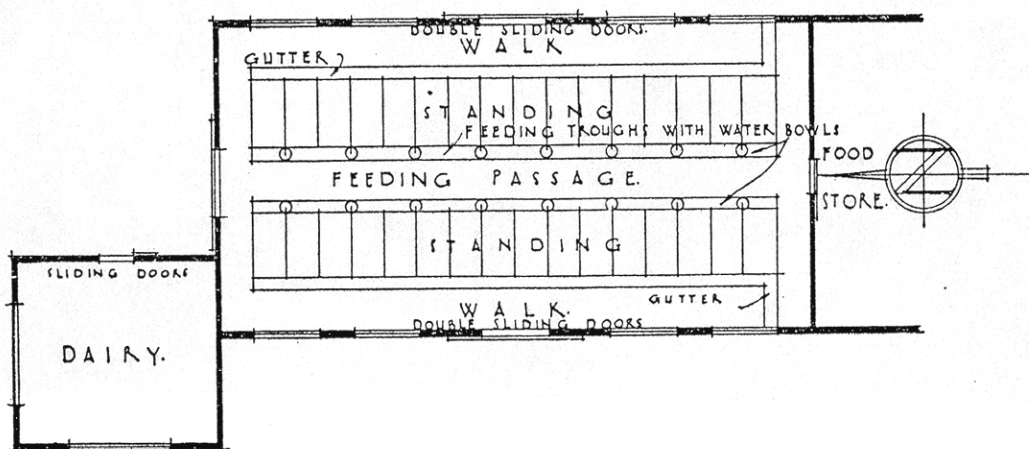

Type 3.—Double range—tail to tail—accommodation for 32 cows with or without feeding passage, as desired.

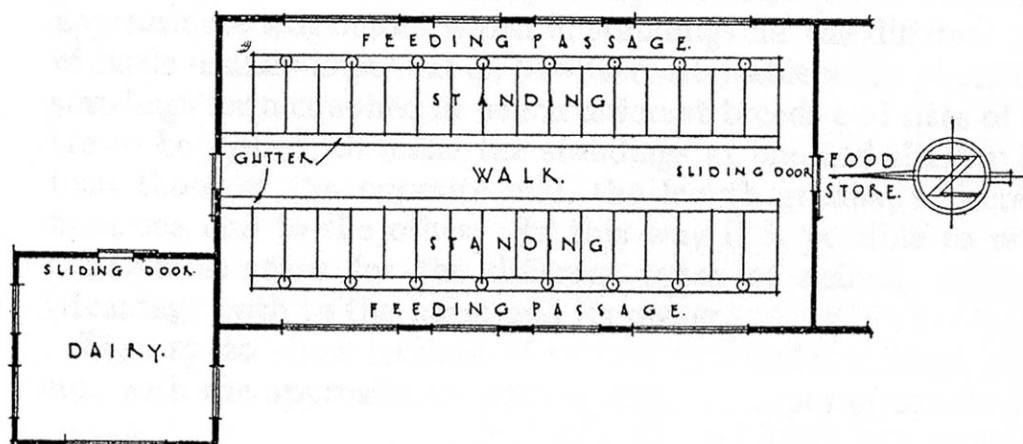

Various arrangements for the housing of dairy cattle
Source: Wm. C. Harvey, *Milk Production and Control*, 1936, p.13

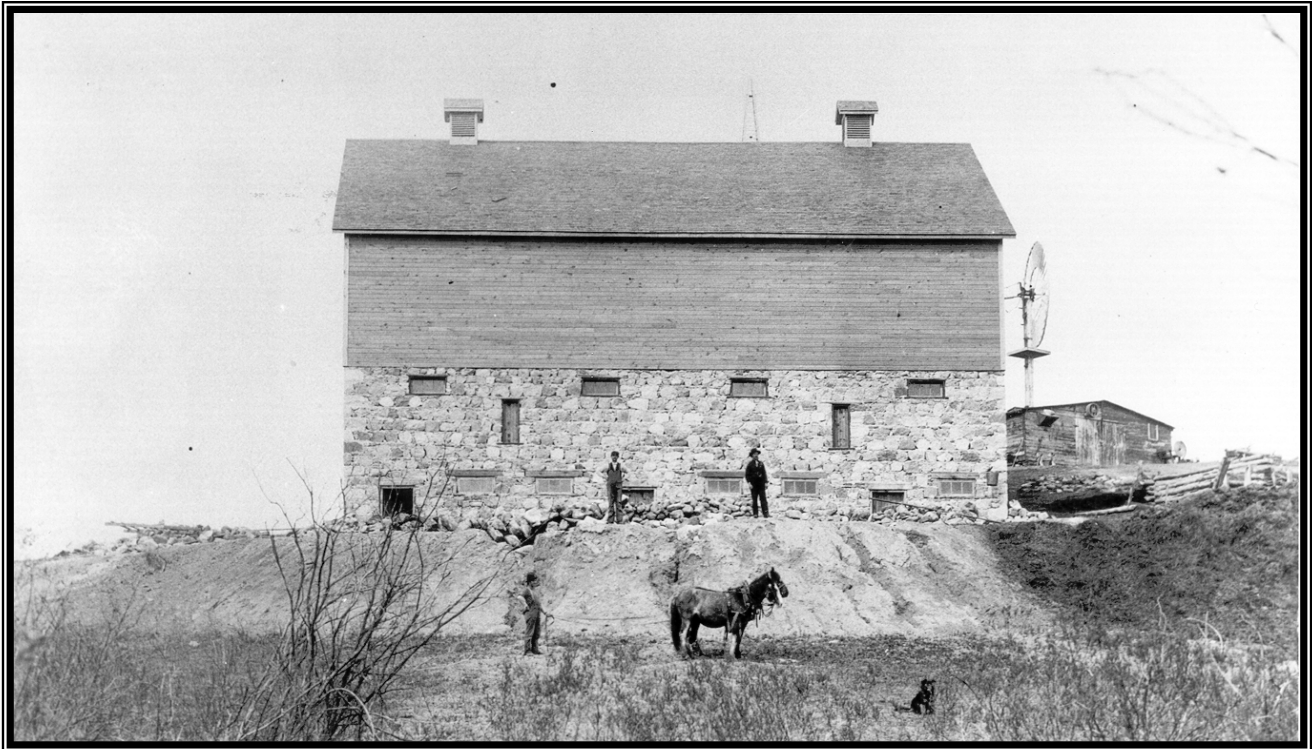

A barn under construction in 1901 at Ninette, Manitoba - This was likely a multi-purpose barn, housing horses, beef cattle, and milk cattle.
Source: PAM, Lowe Collection #10

Obviously, the introduction of electricity on farms greatly improved the lighting in barns, from both a safety and practicality standpoint.

The walls of a barn were eight feet (2.4 m) high, with no open spaces or ledges. The best material for the foundation was concrete because it could be easily cleaned, disinfected or whitewashed. Walls of barns were made of stone, brick, reinforced concrete, breezeblocks, wood or steel. Lime washing, a requirement for dairy barns, was more easily accomplished on a concrete barn. The best floors for a barn had to be non-absorbent, easily cleaned, non-slippery, waterproof, warm and durable. Tile, cork, asphalt, rubber were very expensive so the most common material used for barn floors was concrete. It was reasonably cheap and easy to clean but these floors were damp, cold and slippery for the animals. Often grooves were made in the floor to cut down on the slippery effect.

With the move to modern bulk-milk producing dairy farms, new techniques were designed to increase efficiency of the milking process. Loose housing, which requires less labour, saves bedding, results in less udder and leg injury, and usually has lower construction costs, replaced stall barns, which required expensive concrete work, stanchions, water cups, and ventilation. In the new system there is a resting area where cows rest in a common bedded area on a manure pack. Sixty to seventy square feet (5.6-6.5 sq. m) of bedded area is required per cow. Each day the droppings have to be removed and 10-12 pounds (4.5-5.5 kg) of fresh bedding per cow added.²⁵⁷

Other special areas are needed in modern barns: Maternity quarters, used to keep cows and new calves for the first six weeks; feeding areas where feed rations are placed; an exercise yard, allowing 100 square feet per cow and designed to be cleaned daily by scraping; a holding area where the cows are prepared for milking, and the milking parlour itself. Milking parlours may be laid out in a choice of three patterns: tandem, herringbone, and rotary (See diagram). All these provide more efficient milking procedures.

To accommodate these modern dairy requirements, the large dairy barns of the pre-1960 period have generally been abandoned for the newer system which requires totally different types of structures. No longer are hip-roofed barns, into which large amounts of loose hay were hoisted each summer, necessary, because that method for curing silage is no longer considered adequate. Neither are the cement floors considered the best way of waste management. The floors of the alleys in the new dairy structures are slotted to allow the waste to pass directly to an area below without time-consuming scraping. As a result, cows' feet remain comparatively clean and they track little manure into the milking parlour from the slotted holding area. Their wastes are liquefied and applied to the land as fertilizer, at a later time.

When cows enter the milking parlour, their udders and teats are washed, dried and massaged for 10-15 seconds. Milking begins about a minute later and takes place for 6-8 minutes. Modern milking machines are designed to milk cows gently, quickly and comfortably. The milking unit is removed manually or by computer, as soon as milking is complete, in order to prevent mastitis, and the teats are treated with a weak iodine solution.

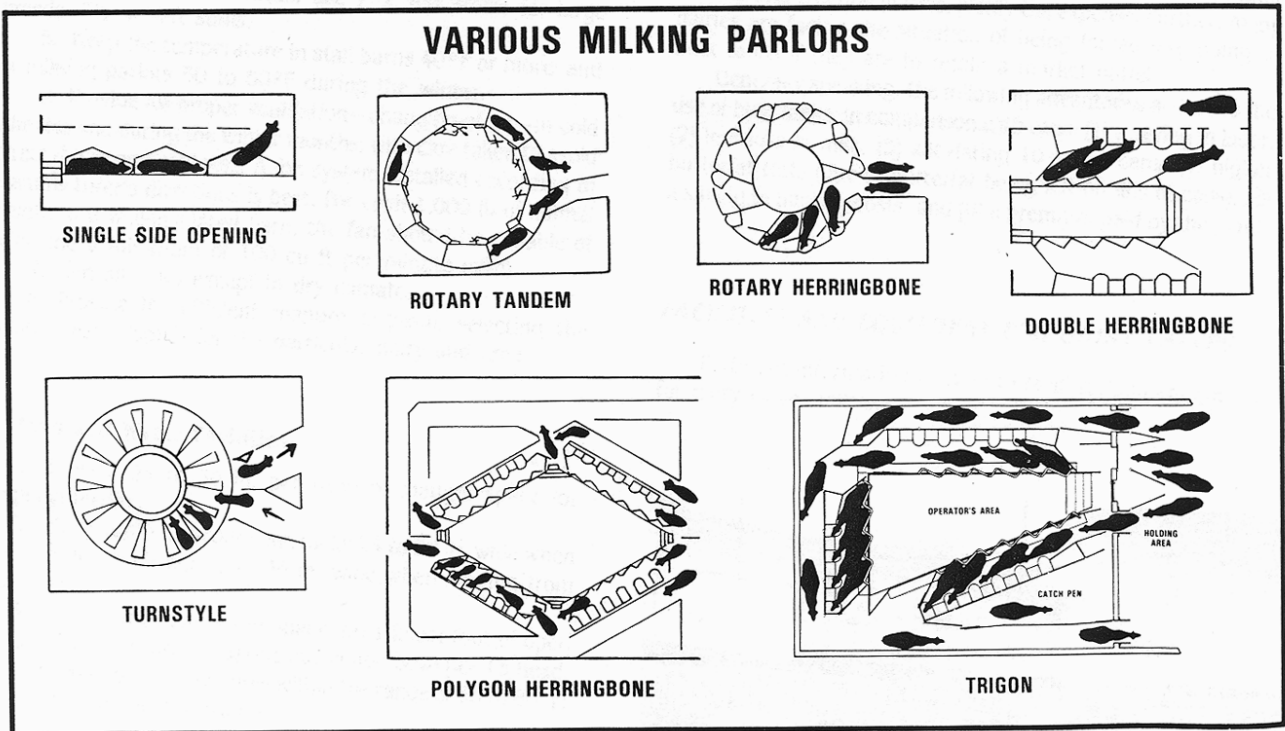

Modern dairy barns are designed to facilitate efficient, fast milking of dairy cows. These are suggested layouts for entry of cattle into milking parlours.

Source: *The Stockman's Handbook*, p.618

The milking machine operates on a two-vacuum system: one vacuum is located inside the rubber liner and the other vacuum outside the rubber liner of the teat cup. There is a constant vacuum on the teat to remove the milk. The intermittent vacuum in the pulsation chamber causes the rubber liner to collapse around the teat, assisting the blood and lymph flow into the udder. Most cows are milked at regular intervals twice a day, although some high producers may be milked three times.

In the milking parlour, there are two types of milking systems: the bucket system and the pipeline system. In the bucket system, the milk is received directly into a nearby-vacuum-like portable bucket either suspended or set directly on the floor. The conventional pipeline systems use a rigid heat-resistant glass or stainless sanitary pipe for carrying vacuum from the milk receiver to the individual milking units and from there to the receiver. Mechanical milking systems consist of four parts: vacuum supply, milk flow, pulsation, and milking unit. Because milk from the cow is the ideal temperature for bacterial growth, it must be cooled to at least 50 F degrees as soon as possible. The modern milking systems, because they take the milk directly from the teat to the storage tank, allow almost immediate cooling.

MILK HOUSE OR DAIRY BUILDING

The milk house was intended to be completely separate from the barn and the house. All dairy utensils were stored and cleaned in this structure. Its design ranged from a square to an octagonal building. With the change to fluid milk pick-up, bulk tanks have been added to the farmyard and these have taken the place of milk houses.

The following is a description of a pioneer milk house:

Father built a good milk house. He dug a space the width of the end (north) of the house six feet or more down, walled it in on all sides with squared logs, which were plastered and whitewashed every spring. The floor was sand. The milk house was entered only through the outside door. A number of steps took one down to the floor. The lean-to was slanted right down to the ground and no one was allowed to climb that roof.²⁵⁸

Dairy houses were generally built away from the house, and preferably under trees, to make the site cooler in summer. The floor was usually dirt and shelves might be hung from the roof in wire hoops so mice could not get onto them.²⁵⁹ The pioneer milk house held no cream separator, but rather the big round pans into which the milk was poured, after straining through cheese cloth or fine wire mesh. The large flat pans were left for twelve hours so the cream would rise to the top. Once cooled, the cream could be skimmed off with a saucer, or a cream skimmer, which was a flat metal spoon with holes in it to allow the milk to drip through. The cream was placed in a crock, and to be churned or sold later. The skim milk was used in cooking or fed to the animals. Once it soured, it could be used for making cottage cheese.

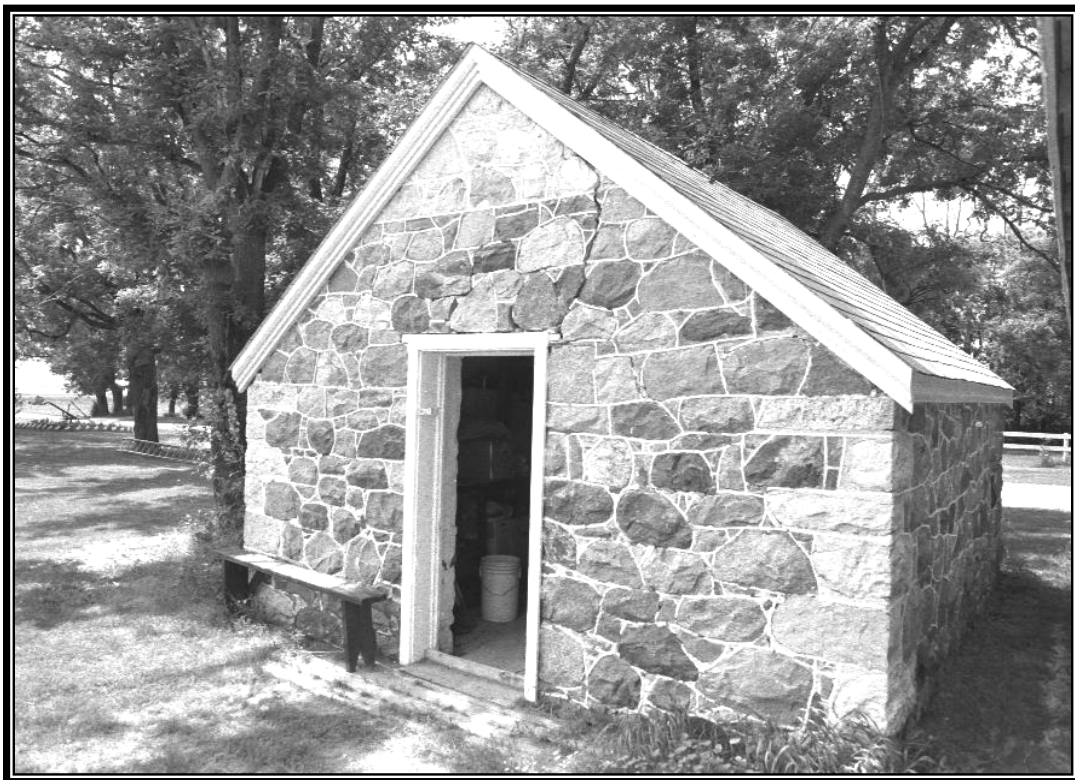

Examples of early Twentieth Century milk-houses in the RM of Rockwood, Stonewall area

Source: Historic Resources Branch photos

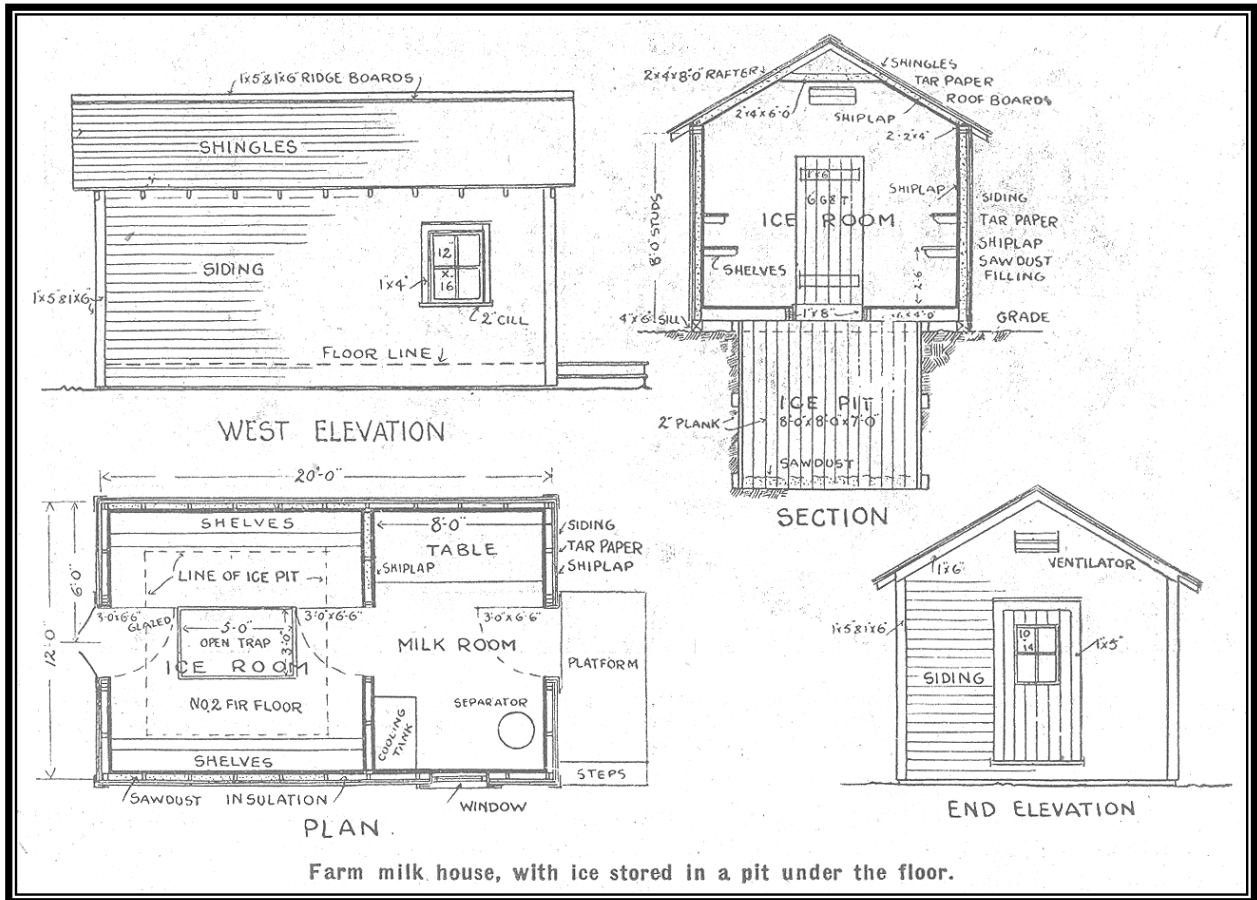

A plan for a typical milk house for a dairy farm
 Source: *Grain Growers Guide*, 19 January, 1916, p.7

RACK FOR MILK CANS AND PAILS

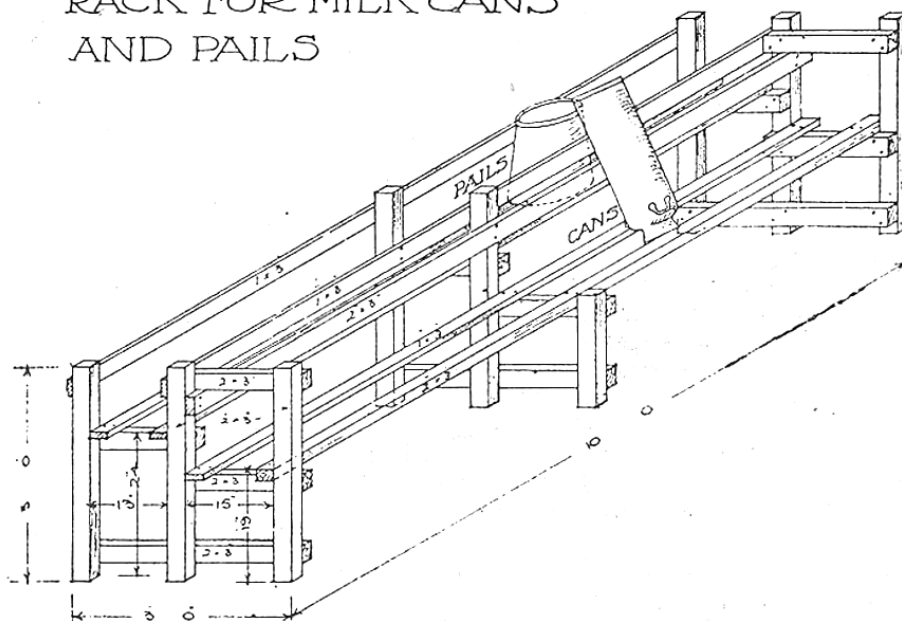

This helps to keep the dairy utensils clean and sweet

BILL OF MATERIALS FOR THIS RACK

- 8 pieces 2" x 3" x 3'.....Uprights at ends and centre.
- 3 pieces 2" x 3" x 3'.....Cross rails at bottoms of uprights.
- 3 pieces 2" x 3" x 10'.....To cut 5 bearers, 21" long; 3 bearers, 19"; 1 bearer, 21".
- 5 pieces 1" x 3" x 10'.....Rails and shelf slats.
- 2 pieces 2" x 3" x 10'.....Rails and shelf slats.
- 2 lbs. 3½" common nails.
- 1 lb. 2½" common nails.

Plans for a structure to hold the milk cans at a milk house
Source: *Grain Growers Guide*, 19 January 1916, p.9

Tall milk cans, with a tap at the bottom and glass to see where the cream had settled, were also used. These were usually set in a tank of cold water to hasten the rising of the cream to the top. The cream separator became prevalent after the 1900s and then the milk house held it, as well as the milk pails and cans.

CREAMERY

A description of a typical creamery in the early 1900s comes from *The Nor'-West Farmer*, February 1900:

The new building which is situated on a rising piece of ground about a quarter of a mile to the north-east of the town, and in full view of the railway, is not as yet quite completed internally, although it has been used for the last month of the 1899 make. When finished it will be a creamery of which the people of Newdale need not be ashamed. The foundation is of stonework and the whole building is well and substantially built. The walls are of matched pine, both outside and in, with the exception of the cold storage compartments, which will be lined with seasoned spruce.

The main building is 30x70 ft., extending east and west and is joined on the south side with a boiler and engine house, 15x18 ft. These dimensions, as may be easily seen, allow ample space for the different departments of the business. The floor of the workroom is raised about two feet on the side where the vats are and the cream is run into the churns with piping. A large elevated cold-water tank is situated in the southeast corner of the workroom and a perfect system of pipes carries water to wherever wanted in the workroom, as well as for washing ice on the smashing floor above the cold storage room. The cold storage room is well situated in the building and will be equipped with a system of eight drying and freezing drums and the ordinary drip trough. Connecting it and the workroom there is a receiving room with one drum. The storage room will be large enough to hold 40,000 lbs. of butter easily. At the east end is a good sized room for the storage of cream cans, etc., which, though not found in many of our western creameries, will no doubt be quite a convenience. A loft over the making room also provides considerable storage room. The workroom is provided with arrangements for heating with stove if necessary and is furnished with one or two handy cupboards in the partition. The well is situated under the east wall and one of the hitherto heavy expenses in operating - viz. hauling water - will thus be eliminated. When fully finished and equipped the total cost will likely aggregate a little over \$2500.²⁶⁰

Before the development of the centrifugal cream separator, creameries used the Swartz system to separate the cream from the milk. This involved setting milk out in large flat pans and the skimming the cream that rose to the top by hand. This was a most wasteful and laborious system.

The most important room in a creamery was the main room, where the cream was weighed, graded and churned, and then formed, printed and packaged as saleable butter. Other rooms included the storage room, office, boiler room, compressor and mechanical rooms, a boxing room, butter-cooling room, ice house, egg and poultry room (used when creameries also graded eggs), and a locker-freezer room where the butter was kept before shipping.

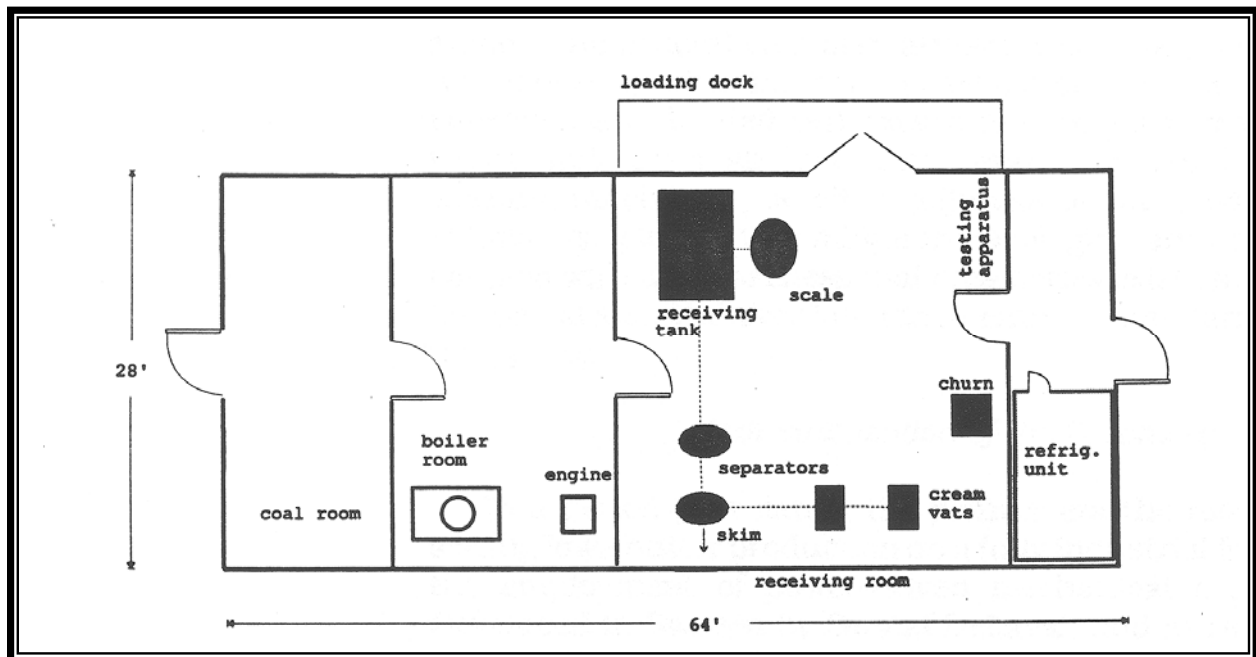

Schematic plan of a ca.1900 whole milk creamery

Source: *PAST - Pioneer America Society Transactions*, Volume XVI, 1993, p.31



Interior of the Fisher Branch Creamery - The butter churn is in the background. Note all the empty cream cans awaiting return to their owners.
Source: PAM Malofie Collection

The equipment in Gladstone Creamery in 1927, although somewhat crude, is probably representative of what most small creameries had in the period: a small pasteurizer, a wooden churn, (800-pound [364 kg] capacity), a steam engine, a small tank for washing cream cans, a Babcock tester, and certain other testing equipment. The only means of refrigeration was ice and 500 tons (454,545 kg) of it was cut each winter, to last through the summer.²⁶¹

CONCLUSIONS

The dairy industry has been an important component of Manitoba's economy since the last decade of the 19th century. The first dairy processors were pioneer women who prepared butter to sell to the local storeowner, in exchange for commodities that they could not produce themselves. The first dairy-processing plants were aimed at farmers themselves. A cheese factory could change a farmer's excess milk into cheese, a food that could be stored more easily, and for longer periods, than milk or cream, and yet met the dietary needs of his family. These first plants were not aimed at supplying an outside market, as much as the farm community itself.

As soon as urban areas began to develop in the midst of farming communities, farmers found another market for their excess dairy products. Town and city dwellers may have kept a cow in their back yards in pioneer years, but found it unacceptable or illegal to do so once neighbourhoods closed in around them. Farms, located a few miles out of the town, began to provide fresh milk, on an early morning basis, to each home in the community. Many of these dairies operated for decades, changing from a loose milk system to bottled milk, and trying to adapt to changing hygienic standards, as set by the departments of Health and Agriculture. Because the health risks were so large, both the federal and provincial governments very early recognized the need to provide regulations for the sale of dairy products. Between the two levels of government, beginning in 1885 with *The Manitoba Dairy Act*, every level of production, and the sale, of dairy products were monitored and regulated. Systems were put in place to control sanitary conditions in processing plants, and the price paid to producers and by consumers, for milk, a staple in the diets of North Americans.

Geographic conditions, population demographics, and transportation trends all dictated how the dairy industry would develop in Manitoba. While much of the land in southern Manitoba was suitable for dairy farming, most of it was too fertile to be used for pasture and to grow fodder crops. The wheat economy that developed on the prairies in the early 1900s caused a decrease in the number of dairy cows. The cheese factories of the 19th century generally closed in the early 1900s, as land was turned into wheat fields. Only land that was too hilly, stony, or potted with water holes, remained the realm of cattle. Whether those herds would be beef or dairy depended on the proximity of the area to an urban market, and the farming traditions of the people of those regions. Generally, the areas where dairy herds prevailed were peopled by French-speaking or German-speaking populations, and situated close to Winnipeg or Brandon, Manitoba's two major urban centres, where a market existed for milk, cream, and butter. Except within the milk shed of these urban areas, English-speaking farmers generally tended to raise Shorthorn cattle, a breed raised for beef.

The depression and drought of the 1930s brought a reduction in the number of beef herds, and fields dedicated to growing cash grain crops. Desperate for some cash income, farmers began to collect excess cream from their few milk cows. While the size of the herd was often expanded, such expansion was limited by the amount of time required by a farm family to hand milk more cows. The cream was shipped in cans, by railway, to creameries which were springing up in every part of the province. With the coming of the Second World War, cheese

factories also reopened. Suddenly, an overseas market existed for butter and cheese, as it had in the 1890s, when Manitoba's cheese and butter had been marketed in Western Canada.

The end of the war brought incredible changes to every facet of agriculture. Mechanized agriculture reduced the amount of farm labour required, and released thousands of people for factory labour in urban centres. Their movement to the city simultaneously increased the market for dairy products. Changes in marketing were also affecting the way the dairy products were processed and sold. In the 1930s, the first chain stores had opened in Winnipeg, and these preferred to control their own milk supply, a product they often used as a "loss leader." Price wars had developed as early as 1932, forcing the Manitoba Government to declare milk a Public Utility, and to create the Milk Control Board. The rationalization of the dairy industry was so dramatic that the number of producer-distributors dropped from 34 to one by 1958. Because health regulations had made it necessary for all milk to be pasteurized and homogenized, something for which few rural milk houses were equipped, producers had a choice between foregoing production or delivering their milk to central dairies, who had the equipment to properly process it.

Creameries were not immediately affected. Farmers, still unsure that good times were here to stay, were reluctant to let go of "their cash cow", so to speak. They continued to ship their cream to local creameries, via the railways. But the transportation system was also changing. With the post-war production of new cars and trucks, market roads replaced railways, which cut the number of shipping points available for farmers. Gradually railway branch lines were abandoned, forcing creameries, if they wished to remain competitive, to establish collection routes, with trucks stopping at each cream shipper's farm once or twice a week. These transportation costs, as well as the costs of modernizing plants that had seen little upgrading since they opened, caused the costs of operating a creamery to rise. Added to this was the disappearance of butter sales, lost to the introduction of margarine in 1949. Amalgamation of creamery companies began in the 1950s, but soared by the end of the 1960s. Of the more than 130 creameries that had existed across Manitoba, only big firms, such as Modern Dairies, Manitoba Co-operative (Manco), People's Co-op and Safeway's Lucerne remained in the market. Further downsizing would follow in the 1990s when the price of milk was de-regulated. National, and then international, firms entered Manitoba's market place.

But if trucks could visit farms on a regular basis to collect cream, why couldn't they collect milk as well? Surely the creameries had better equipment for separating the cream from the milk than the old hand-turned cream separator, that was the bane of every farm woman's existence! The problem was that milk, unlike cream, could not be safely stored for long periods. But refrigeration, made possible by rural electrification in Manitoba in the 1950s, removed this concern. Milk could be safely refrigerated and collected, in bulk, by trucks, providing that farmers installed bulk tanks to store it until the tanker arrived. A huge investment was necessary to create the kind of modernized dairy farm that would send the milk directly from the cow's udder to the tank, to the truck, and thence the processing plant, all without being contaminated by human touch. The money needed to adapt to this specialized form of dairying came from government grants. These were accompanied in the 1970s with the national quota system, which placed the Canadian dairy sector under a supply management plan. Each province was allocated a national quota for milk production, based on its historical share of the market. Then farmers in the province were allocated a portion of this quota. Today, no farmer can decide on his own to create a dairy herd and become a dairy farmer. He must purchase an existing quota, often valued higher than the price of the dairy herd.

The Milk Control Board, which is part of the supply management plan used for marketing milk and maintaining a stable price, has been under attack in recent years as the price of milk paid by the consumer has risen dramatically. Without the marketing boards and quota system, which set the price paid to producers for their milk according to the costs of production, such as gasoline prices, animal feed, and new barns, etc., many experts believe the price of milk would be dictated by more efficient production. In the present scheme, there is little incentive to produce more milk than your quota allows, and therefore no incentive to improve operations. "The gap between formula-driven prices and an open system keeps Canadian farms smaller and less efficient, with underutilized capacity and lower yields."²⁶² Recent decisions by the World Trade Organization point to an eventual end to supply management in Canada.

The technological advances in dairying have changed the look of a dairy farm considerably. Today's barns are free-stall and bear no resemblance to the large hip-roofed barns that once dotted Manitoba. A more visible symbol of a modern dairy farm is a large stainless steel tank. Nor are the fields dotted with herds of black and white Holsteins or taffy-coloured Jerseys. Few cows are nurtured on natural pasture. They are given high-protein feeds, kept in confined environments, artificially inseminated, and their excess calves, produced to maximize their mother's milk production, are converted into ground beef for firms such as McDonald's!

In Manitoba today, there are over 600 bulk -milk producers - the modern version of a dairy. Of these, the majority are located in eastern Manitoba, the Interlake and the Pembina Hills regions, but certainly they are not limited to these areas. The amount of milk produced by these farms is larger than was previously produced by more than 20,000 producers. Many of these bulk milk-producers are the descendants of the families who first delivered milk to local customers. Today's generation of dairymen do not have to labour as hard as their forefathers to collect the milk, but they must be more educated, working with computerized equipment and records of performance. Many of these operations are run more like corporations than family farms.

The period of dairy farming which involved the largest number of Manitoba's citizens and therefore had the greatest impact on this province's development, was the period from 1932-1960. Historical remnants of this period can be found on farms scattered across southern Manitoba and in abandoned creamery buildings located across the same area.

INVENTORIES

These inventories of processing plants are not complete, nor definitive. They contain only those operations for which some references have been found in the research materials consulted.

The firms that appear under milk plants may also appear in the creameries inventory. Some dairies produced not only milk but other dairy products such as butter, cheese, and ice-cream. Wherever possible, an attempt has been made to place them in one category or the other. It is a good idea, however, to cross reference the two lists.



Modern dairy operation located near Blumenort
Source: Historic Resources Branch photo

MILK PLANTS

Averbuk, J., Winnipeg: Delivering milk in 1920

Avondale Dairy: Operated by Bert Rootsaert in the Rosser area during the 1940s

Beausejour Union Milk Dairy and Produce Company: Operating in 1901

Bendman, J., Winnipeg: Operating in 1920

Birmingham, R.A., Brandon: Operating in 1920

Bossuys: Constant Bossuyt arrived in Canada in 1897 and settled near the present Winnipeg Canoe Club in St. Vital. He then moved to Kingston Row, ferrying his milk across the river to sell it. In 1902 the family moved to Fort Garry and called their farm the Manitoba Dairy. Bossuyt bought the North Western Dairy that had previously been supplying the milk to Fort Garry residents. The dairy was a family run organization with the young son, C. Archie being responsible for recruiting new customers. The family rose at 4:00 A.M. to milk and finished their day at 9:00 P.M., when the night milking was completed and processed. In 1920-21, the Bossuys' entire herd of 64 cattle had to be destroyed because of TB. Economic disaster struck again in 1942 when the Bossuys' barn burned and they lost all but nine head of cattle. In 1943, the Bossuys, with 85 head of cattle, moved to the Oak Bluff area. Hand milking took about three hours before 1948 when the Bossuys introduced milking machines. The milk was placed in eight-gallon (36-litre) cans and hauled to Crescent Creamery in Winnipeg. To feed the cows, malt was purchased from Kiewel's Brewery in downtown Winnipeg and used to supplement the hay and corn grown on the family farm. Until 1955, when a labour-saving barn cleaner was installed, the barn was manually cleaned twice a day and the manure was hand spread on the fields. The family continued to add modern buildings and machines to the operation, expanding their dairy herd, as the three sons became part of the operation with their father. In 1973, the sons formed the Bossuyt Brothers Company and took over the operation of the large herd and farm at Oak Bluff. The milk was contracted to processors such as Beatrice.²⁶³ In 1982, the dairy herd and the milk quota was sold to a farmer in western Manitoba.²⁶⁴ The family continues to farm the land in the Oak Bluff - Sanford area.

Brandon Creamery Farm: Located on 21-10-19W, in what is now the western part of Brandon along Hwy. #1A. Ed Fotheringham ran a herd of purebred Holsteins here. He purchased purebred bulls from Carnation Milk Farms in Seattle, Washington. Their off-spring were high producers and were sold to buyers in England. The herd was dispersed when Fotheringham died. The farm was managed by Robert Cox.²⁶⁵

Brandon Pure Milk, Brandon: Owned by Crescent Creamery in 1940s. Started a milk route in Minnedosa in 1949, starting a price war there. Sold to Modern Dairies in 1955.

Cambridge Dairy, Winnipeg: Operated by the Van Walleghams near the site of the present-day Pan-Am Pool on Cambridge St. This family of six brothers began arriving from Belgium in 1898. A. Van Wallegham began working with the Bossuys in 1902. Then he moved to the present Cambridge Street area and started the Royal Dairy in 1904. The brothers rented pastureland on the prairie that would become River Heights. The young sons were put to work herding the cattle or driving the milk delivery wagon. To cool the milk for customers, the fresh milk was run over a surface cooler with ice water running through the coils before it was put on the delivery wagon, which left the farm at 8:00 with 150 to 200 calls to make. The milk was kept

from freezing by using charcoal heaters in the wagon. The driver, unfortunately, did not have any heat, making milk delivery a most uncomfortable job during the winter. In 1936, the Van Walleghams bought their first truck for delivering the milk. By then, they had moved their herd outside the city to the Elm Creek area, although their processing plant remained in River Heights. The company offered its customers raw and pasteurized milk until 1950, when, as a result of the 1950 Flood, the dairy began to concentrate on pasteurizing milk for all the small dairies around Winnipeg.

Carlaw's Dairy: Located in St. Vital in 1930s. Carlaw later worked for Modern Dairies

Cartwright Dairy: Operated by James Trembath in Cartwright during the 1950s

Central Dairies: Established in Winnipeg in late 1930s and purchased by Modern Dairies during World War II.

Chapman Dairy: Originally known as Brookfield Dairy, this was started by Frank and Nellie Chapman, around 1913. Brother-in-law, Edwin Fardoe, worked for the Chapmans and purchased the dairy when the Chapmans returned to England. The Chapmans returned to Canada and repurchased the dairy in the 1920s. It operated until 1943.

Cheetams Dairy: Operating in Fort Rouge before World War I

City Dairy, Winnipeg: Operating in 1920. Owned by J.M. Carruthers and J.W. Hillhouse, former employees of Crescent Creamery, who, in 1923, formed an agreement with the Winnipeg District Milk Producers Co-operative Association Ltd. by which they would deduct membership fees from the milk cheques of the Co-op members. In return the Co-operative would encourage cream shippers to ship to City Dairy, thus increasing their butter-manufacturing business. Partnership broke down in 1929.

Cloverdale Farm: Located thirty miles east of Winnipeg, W.H. Carter had 130 cattle, chiefly Holsteins, on 3600 acres (1450 hectares).

Crescent Creamery, Winnipeg: Delivering milk in 1920

Cruise Dairy, Dauphin: In 1926, Bill Cruise started a dairy business on the southeast edge of Dauphin. With 40 head of cattle, and using the house for the bottling operation, the Cruises sold two quarts of milk on their first day of service. A new barn, capable of holding 65 cows, was built in 1927. A new milk house was added in 1931. In 1938, Cruise entered a partnership with Joe Dufault from St. Boniface and a new processing plant was built in Dauphin, at the corner of First St. and Second Ave. The dairy farm was thus separated from the processing plant. The plant produced 250 quarts (284 l) of milk daily. The partnership was dissolved in 1941 with Dufault carrying on the name of Cruise Dairy. The business was sold to Adolph Gniazdowski in 1956. Milk output was increased to 3000 quarts (3,411 litres), with raw milk supplied by more than 20 dairymen in the region. In 1961, the dairy processing plant was sold to Manco.

Devisscher Dairy, Winnipeg: Had its milk pasteurized at the Royal Dairy before distribution.

Doerns, Morden: In 1914, the Doerns were delivering their milk door-to-door in Morden, selling it for 20 cents per quart.

Elliott's, Stonewall: Dennis Elliott delivered milk to Stonewall residents in the 1920s. Other dairies delivering milk in the area were Bonar Chanin, Alf Prime, Bob Mann Sr., and Francis Appleyard.

Finkle, B., Winnipeg: Operating in 1920

Fort Rouge Dairy: Started by Nestor and Germaine De Meyer in 1937 on Waverly Street, on a dairy purchased from William Humphrey. They first peddled their milk with horses but then bought a truck to handle two milk routes. Because the city was expanding into their dairy land, and because milk inspections had become strict, the family relocated to Oak Bluff after the war, establishing a modern operation with bulk tanks and pasteurizing equipment. They named the new dairy, Perimeter Dairy.

Fowler, G., Portage la Prairie: Operating in 1920

Frechette's Dairy, The Pas: Nazarre Frechette came from Quebec in 1916 and started a dairy on La Rose Avenue with two cows. As the business grew, he built new buildings from lumber he milled himself. In order to keep up with demands for milk in The Pas, he ordered a carload of cattle from St. Boniface in the early 1920s. These turned out to be diseased with TB, in spite of claims from the seller that they had been checked. The herd had to be destroyed and the Frechettes started over. In 1924, the dairy was relocated farther out of The Pas to present-day 13th and 14th streets. By 1927, the operation included 100 cows and 100 pigs, as well as a processing plant. The first milk pasteurizer in the North was installed there. Soon Nazarre was expanding to the new mining town of Flin Flon, where milk was bottled and sold door-to-door for a few years. All the dairy cattle were sold in 1952 and the Frechettes concentrated on the dairy processing plant, which supplied the North. The Frechette sons, Marcel and John, took over the plant in 1955 and sold it to Modern Dairies in 1962.²⁶⁶

Garrioch, V., Portage la Prairie: Operating in 1920

Gartmore Guernsey Farm: Owned and operated by Art Rampton, on the land where one of the early settlements in Dauphin area, Gartmore, was established, this dairy and processing plant opened in 1964. Art Rampton was also a big supporter of the Canadian Guernsey Breeders Association.

Glencairn Farm, Selkirk: Owned by J.W. Sifton, then T.A. Crerar, and then D. Schneider, this farm at Clandeboye had one of the largest dairy herds in Canada.

Grinbach, Louis, Winnipeg: Operating in 1936

Hazelglen Jerseys: In 1912, W.D. Aime brought two registered Jerseys from North Dakota. In 1914, he added a registered Jersey bull, bought from J.H. Baskerville of Dominion City. In 1920, the Aimes moved their herd, called Hazelglen Jerseys, to Clandeboye. Aime continued to add registered Jerseys to his dairy herd and became a member of the Canadian Jersey Cattle Club. From 1920 to 1930, the Aimes shipped cream to Manitoba Co-op Dairies. In 1931, low cream prices caused them to decide to go into the milk delivery business. They began to deliver Hazelglen products directly to Selkirk. This continued until 1962, when they went into bulk milk pick-up.

Hillhouse Dairy: Established by Alois Degrave in the Rosser area in 1893. His son, Julian, operated the dairy business from 1946-1976.

Home Dairy: Formed in 1932 by Abe Greenberg, veteran milk producer, and Crescent Creamery, as a North End subsidiary of Crescent Creamery.²⁶⁷ Also called Central Dairy.²⁶⁸

Kruger, J., Winnipeg: Operating in 1920

Lasker, P., Winnipeg: Operating in 1920

Lilyfield Dairy: Started in 1905 by Bill and Rose Hughes. Delivered milk to customers in the Point Douglas area of Winnipeg until 1943.

Manitoba Co-op Dairies, Dauphin: Operating in 1936

Manitoba Dairies Limited: A dairy farm at Marchand in 1934, with 800 purebred Holsteins. The farm was scrupulously clean and scientifically run, with a veterinarian on staff. The milk was shipped each morning by train to Winnipeg.

Maple Grove Dairy: Operated by Arthur Bailey in the Rosser area

McKillop Dairy, Dauphin: Operating in 1947

Modern Dairies: Built by A. De Cruyneare in 1920s. Purchased by J.W. Speirs in 1931. Speirs, formally with Crescent Creamery, used his experience to make Modern, with its newest, most efficient milk plant, a company capable of taking over a quarter of the Winnipeg market.

Mowats, Portage la Prairie: Around 1925, a milk-distributing plant was established on Main Street by Alfred Mowat. Around 1932, it was moved to Tupper Street as the Crescent Butter Plant where Mowat ran a dairy plant as well as milk deliveries. The plant, which produced butter and ice cream, was sold to Alex Rey in 1949 and then to Crescent Creameries.

Palm Dairies, Winnipeg: Calgary-owned firm established a branch in Winnipeg in 1941.

Parkdale/Parrish Dairy Farm: Established in 1889, in West St. Paul, north of Winnipeg between Lockport and Lake Winnipeg, the farm covered 2200 acres (891 hectares) and had 310 dairy cattle, mostly Holsteins and Jerseys. In 1935, it was the only dairy producing "Certified Milk", which meant it had the approval of the Manitoba Department of Health and Welfare. Small-topped milk pails (which allowed few extraneous particles to fall into the milk) were used and the milk was cooled to 40 to 50 degrees Centigrade within minutes of milking, and bottled on the farm. The dairy had a contract to supply Winnipeg hospitals, and also Piggly Wiggly stores. Their product was sold as Parkdale Certified Milk or Parrish Special Milk. W.L. Parrish, who bought the dairy farm, also had a string of grain elevators and operated the dairy farm as a hobby farm from 1924-57. Then the farm was changed into a beef and feed-lot operation.

People's Co-op, Winnipeg: First known as Workers and Farmers Co-op, the People's Co-op entered the milk-processing field in 1931 after being petitioned by many of the milk producers in northern Winnipeg. The Co-operative was first formed in 1923, to purchase fuel in bulk so that its members in the North End could afford to buy it. The co-operative bought a bakery at Dufferin Avenue and Henry Street and modified it to a milk-processing plant, to which many of the dairy farmers contributed seed money. The co-op was immediately engulfed in a price war with the big companies, Piggly Wiggly, City and Crescent creameries. The co-operative built a

solid milk delivery business that outlasted most other home delivery companies in Winnipeg. It was purchased by Dairyland in 1994.²⁶⁹

Pine Falls: Had a milk plant in 1930s

Pine Valley Dairy: Operated by Peter Blek in the Rosser area

Prairie Rose Dairy: Operated by Edwin Fardoe in the Rosser area

Primrose Dairy: Operated by Alfred Church in the Rosser area

Pure Milk Company, Winnipeg: Winnipeg Pure Milk Company combined with Munroe Creamery in 1903 to form Pure Milk Company, with a capital of \$20,000, 1800 acres (709 hectares) of land, and 180 cows, which were increased to 400 cows. Became part of Modern Dairies.

Rampton's Dairy, Morden: Operating milk delivery in the Morden area in 1920s

Richardson, A., St. Boniface: Operating in 1920

Red Rose Dairy: Owned by Oscar De Meyer family, a Belgian family who came to Canada around 1910. They purchased a dairy in Tuxedo and renamed it the Red Rose Dairy. Three of the sons each had a milk route, pouring milk into customers' receptacles each morning, while the daughters had the job of washing all the cans and bottles.

Regal Dairies, Winnipeg: Operating in 1947

Roseberry Dairy, Winnipeg: Operated in St. James area

Rosser Dairy: Operated in Rosser area by John Hill in the 1920s to 1940s

Rossfield Dairy: Operated by Steve Dzogan in the Rosser area

Royal Dairy: Established a milk plant in Winnipeg in late 1930s

Silverwoods: This large Ontario-based dairy corporation purchased City Dairy in 1943

Smallwood, J. Dairy, Winnipeg: Located in St. James area

Smyth, R, Brandon: Operating in 1920

Standard Dairies: Established by the Associated Retail Grocers in Winnipeg in 1930s. Purchased by Modern Dairies in 1936

Stant Bent Dairy: Operated by David Brownlee in the Rosser area

St. Andrew's Dairies: Established by Albert Paquin in 1920s

St. Boniface Creamery Co. Established by Charles Gaudette in the 1920s

St. Norbert Dairy: Operating a door-to-door delivery service in St. Vital area in the 1930s

Sundale Dairy: Large plant on Henry Ave. purchased by Piggly Wiggly in 1931. Sold to Safeway in 1936

Swift Canadian Co., Dauphin: Operating in 1936

Swift Canadian Co., Winnipeg: Open in 1936

Taillieu, F. St Boniface: Delivering milk in 1920

Thomas, J.T., Portage la Prairie: Operating in 1920

Verhaeghe, C. St. Boniface: Delivering in 1920

Wakeman, H.G., St. James: Delivering milk in 1920

West End Dairy: Operated by William Dowbenko in the Rosser area

Winnipeg Pure Milk Company: Incorporated in 1902 with a capital of \$40,000

CREAMERIES

A.R.G. Creamery: St. Boniface: Operating in 1934

Arborg Creamery: Cooperatively owned by the North Star Co-operative in 1920, the creamery added a cheese plant in 1969. In 1971, this plant was sold to Bothwell Co-operative from New Bothwell who used the plant to make butter and cheese.

Ashern Creamery: Opened in 1914. Owned by Dominion Produce Company in 1921. It burned in 1930 and was rebuilt. It then operated as a farmers' cooperative for many years.

Austin: Walter Clifford came from Devonshire, England in 1884 to settle in Austin, located on the Canadian Pacific Railway mainline. He purchased a dairy herd and established a creamery at an ideal site beside Squirrel Creek, from which water could be used for washing the butter. He installed a pipe from the creek to the creamery, which he furnished with up-to-date equipment such as the first cream separator brought to Manitoba. Clifford contributed to the first shipment of butter sent to British Columbia, but, by 1888, he was disappointed in the failure of a local market to develop and closed the creamery. He offered his expertise to the local community when they established the North Norfolk Creamery Association in 1896.²⁷⁰

Beausejour Creamery: Built in 1920 by D. Greenberg. Burned in 1931, but rebuilt by E. Greenberg and Son. In the thirties, the creamery made 425,000 pounds (192,743 kg) of butter per year, but when that market dropped off, Sam Greenberg built a successful print butter business in the 1950s, contracting to cut up and wrap large quantities of butter for packing companies. This butter was shipped directly to retailers. The creamery was still in business in 1980.

Belmont Creamery Company Ltd.: Opened in 1913, just east of town, with a board of directors and financed by selling shares. The first manager, George Nunnerly left to enlist in 1914. A fire destroyed the creamery in 1919, but the shareholders decided to rebuild at once. The creamery had a good supply of cream and eggs, shipped by Canadian National Railway, and delivered by the local drayman from the station. In 1941, the creamery made 410,175

pounds (186,443 kg) of butter. After the war, trucks followed routes to Wakopa, Mariapolis, and Baldur to collect the cream. During 1953-54, butter production doubled. In 1956, a new butter churn, with a 1300-pound (589-kg) capacity, was installed. That year, the creamery won first prize for the cleanest creamery in Manitoba, and three awards for butter making. It also was the only Manitoba creamery to be awarded a first prize at the Royal Winter Fair in Toronto. In 1958, the shareholders agreed to sell the creamery to R.J. Vaudry. The creamery was destroyed by fire in 1967 and never rebuilt. By this time, cream production had slowed down and bulk milk collection had begun.²⁷¹

Barnardo Home Farm Creamery, Russell: Part of the Barnardo Home Farm for turning young orphan boys from England into farmers, this creamery was built in 1888. The first creamery building burned in 1896 and the new building was more modern. The one and one-half story building was 76x40 feet (23x12 m). It had a square-cornered, wooden churn, hung between two heavy timbers and driven by a steam engine. In 1896, butter from the creamery captured a gold medal at the World's Fair. Charles Ruddick, the butter maker at the creamery, later worked for Smellie Brothers in their creamery at Shoal Lake. A description of how the cream for the plant was collected along country roads exists:

In gathering the cream at a farm, they used an iron arm clamped to the side of the wagon. On this they hung the spring scale to weigh the various pots, lard tins, etc. containing cream. These were then emptied into a barrel in the wagon, which held 200 pounds [91 kg]. The wooden barrel had an inner sanitary tin container, with a V-shaped splash pan and heavy lid. There was no grading so all the cream was mixed together and delivered to the creamery.²⁷²

The creamery was shut down when the Barnardo Home closed in 1906

Birtle Creamery: Opened around 1900. Offered for sale in 1902

Brandon Creamery Company: Established by J. Bousfield on a summer schedule in 1897 under the name, Brandon Creamery. R.A. Lister Company operated it in 1898. Became Brandon Creamery and Supply Company in 1903 when it moved to a new larger location. A cold storage plant was built in 1912. Sold to Manco in 1945

Brandon Crescent Creamery: Sold to Manitoba Dairy and Poultry Cooperative (Manco) in 1927

Brandon Stirling Creamery: Sold to Manco in 1946

Brandon Produce Company: Operating from 1915-1917

Cambridge Dairies, Winnipeg: Operating in 1947. Owned by Van Wallegghem family and located where the Pan -Am Pool is now located.

Canada Packers Limited, Winnipeg: In 1940, Canada Packers, with a Produce Division in Winnipeg, began to purchase dairy-processing plants in Winnipeg. The T. Eaton Co. plants at Winnipeg, Melita, and Rapid City were bought. The Winnipeg plant was closed. In 1942, the Manitou Creamery was added and in 1944, Glenboro and Crystal City were purchased. Next the Swift Canadian plant in Dauphin was acquired and then the Souris Creamery in 1951. Egg grading and poultry processing were foremost at these country stations, with the products shipped to Winnipeg or St. Boniface. The company also opened a cheese-manufacturing plant

in Winnipeg. For twenty years the creameries were fairly successful but, in 1960, the amount of farm separated cream shipped to local creameries began to decline as farmers shifted to less labour-intensive agriculture. Faced with a capital expenditure to centralize and adapt to fluid milk collection, Canada Packers opted to sell their creameries. Modern Dairies purchased Melita, Glenboro, and Crystal City creameries in 1966, and closed the latter two in 1972. Dauphin and Rapid City creameries were sold to Manco. The Dauphin plant was closed in 1967. Manitou remained a cream-receiving station from 1959 until it was closed in 1977.

Canada Packing Company, Winnipeg: Started in 1920 and was sold to Saskatchewan Co-operative Creameries in 1924. The plant was resold to City Dairy in 1928.

Carberry Creamery: Operated between 1913 and 1920

Carman Creamery: A joint stock company was formed in 1912, and a building 20x42 feet (6x12.8 m) and 20 feet (6 m) high was erected. The engine room was supplied with a 15-horsepower boiler and a 10-horsepower engine and steam pump. The creamery contained a butter-making room with the latest machinery: a combined churn and butter worker which could handle 740 pounds (335.6 kg) at one churning; and a combined pasteurizer and cream ripener. An area for washing and steaming suppliers' cans was situated next to the refrigerator, which had a capacity of 300,000 pounds (136,000 kg). An ice house, holding one hundred tons (45,454.5 kg) of ice, supplied the refrigeration. The secretary, C.A. Andrews, and the butter maker, A. Christiansen, were very experienced, and produced 400 pounds (181.4 kg) of butter in one week. By 1914, however, a lack of sufficient cream supplies threatened to close the factory. Since the creamery paid four cents more per pound for butterfat than Winnipeg creameries, there was more a lack of dairy cattle than a lack of support. In 1914, the creamery was leased to A.S. Reddick and W. Weir of Winnipeg. Under their management, the creamery produced 2800 pounds (1,270 kg) of butter per week. But when the two operators entered military service in 1915, the creamery was sold to Crescent Creamery of Winnipeg. They intended to use the Carman plant for butter making. E.B. Jensen was hired to operate the plant in 1915, and in 1934, he and a partner purchased the creamery. Jensen and his son, Sven, operated the creamery until 1966 when they sold it to Modern Dairies. The Jensens had replaced the 1910 structure with a new building in 1965. The plant was closed in 1968.²⁷³ Sven Jensen was appointed manager of Modern Dairies in 1977.

Carberry Creamery: Opened 1897. A new one opened in 1913

Cartwright Creamery: Shares were sold to create a creamery company which opened for business in 1913. The creamery had a capacity of 1500 pounds (682 kg) of cream daily. It was sold to George Matheson in 1920. In 1937, J.M. Shewfelt of Belmont became Matheson's partner. The creamery produced 225,000 pounds (102,273 kg) of butter in 1937. In 1938, a 300-pound (136-kg) cherry pasteurizer was installed. Shewfelt became the sole owner in 1944. In 1952, the creamery purchased the Killarney Creamery, and Shewfelt's sons became the managers. In 1958, a butter wrapper was installed in the Cartwright Creamery. It could mould and wrap 1400 pounds (636 kg) of butter in one hour. Also installed were stainless steel vats, a surface cooler, and a stainless steel churn. The local dairyman, James Trembath, had his milk pasteurized at the creamery before delivering it to Cartwright's customers. Sold to Modern Dairies in 1969 and closed in 1970.

Central Creamery, Winnipeg: Sold to Modern Dairies in 1945

Central Creameries, Brandon: Originally started by John Tungeland. Acquired by Ed Fotheringham who sold it to Manitoba Co-op in 1945. Closed in 1967

Chatfield Creamery: Built in 1934 by Manitoba Co-op. Sold to John Jaremy in 1942. He was an excellent butter maker who frequently won awards for best wrapped print butter.

City Creamery, Winnipeg: Operated by H.B. McIntosh from 1913-1914

City Dairy Ltd., Winnipeg: Operating in 1920. Merged with Canada Pure Milk Company in 1929 to become one of the big players in setting the price of milk prior to 1932. Also had a creamery in St. Claude from 1925 to 1930, and a plant in Grunthal during the 1930s.

Crescent Creamery Co., Winnipeg: The Crescent started on Hargrave Street and then moved to Lombard Avenue. In 1914 it moved to Sherburn St. The company bought Carson Hygienic Dairy on Maryland Avenue in May 1914. Had a skim milk plant at Clandeboye and at Letellier in 1913, as well as plants in Brandon and Killarney. R.A. Rogers, owner of the company sold the company to Eastern Dairies in 1927. By 1934 the company also had a plant in Portage la Prairie, and by 1947 another in Swan River. Sold to Modern Dairies in 1956

Crystal City Creamery: The first creamery was established on the Thomas Greenway farm, Prairie Home Farm, where Greenway had a sizable herd of Shorthorn and Ayrshire cattle. William Ostler was the butter maker. A modern creamery was built in 1902. Purchased by Canada Packers in 1944 and sold to Modern Dairies in 1966. Closed in 1972

Dairy Products, Neepawa: Operating in 1947

Dauphin Creamery: Built in 1907 and operated by A. Code from 1909-1920. It was purchased by Crescent Creamery Co. in 1920, and sold to Manitoba Co-op in 1928. In 1961 Manco also bought the Cruise Dairy and combined the operations with the creamery. Over the next three years the plant was modernized with a pasteurizer, carton machine, boiler room, vacuumizer, ice facilities and a office. In 1964 the plant introduced a new three-quart glass container for pasteurized milk, the first such in Manitoba. In 1970 the conversion to bulk hauling brought milk from 11 producers to the plant. Today Beatrice division of Parmalat runs the Dauphin plant, the only one in Parkland region.

Deloraine Creamery: Incorporated 1894

Dominion City Creamery: Built in 1938 by A. Christianson, but sold to various owners before it burned in 1950

Dominion Produce Company, Winnipeg: Established by Tom Eliot who bought several creameries including Dauphin, Inwood, Ashern, and Winkler. He sold the company to Ed Fotheringham of Brandon in 1923. Fotheringham purchased the Holland Creameries at the same time.

Douglas Creamery: Announced 1894

Elkhorn Creamery: With applications for 77 shares and a promise of over 200 cows, the Elkhorn Creamery Company was formed in 1910. Shares were selling for \$10 with a limit of 30 shares per person. The company had hoped to receive assistance from the Manitoba Government but was offered this in the form of the out-dated and neglected equipment and

buildings of the Birtle creamery. Instead the company hired E.A. Parsons to build a new creamery building near the CPR depot. Plant machinery was purchased from the St. Jean-Baptiste Creamery. Operations commenced in April 1911, with 5311 pounds (2409 kg) of butter produced in May by an experienced butter maker from Minnesota, A.V. Holmgren. By 1915 the creamery had enough patronage to stay open all year around. The demand for butter in the West was high enough to warrant ordering new equipment, such as a pasteurizer. By 1920, the company increased its capital stock and expanded its facility. A new refrigeration plant and an ice-cream plant were installed, making 1921 a booming year for the factory. Disaster struck in June 1922 when the inadequately insured business was destroyed by fire. The Brandon Creamery purchased the site in 1929 and moved the equipment from Narcisse Creamery to Elkhorn. Once again the Elkhorn Creamery, under Cecil Paddock, won awards for its butter and ice cream. In 1945 the enterprise was purchased by the Manitoba Dairy and Poultry Co-operative who made a huge addition in 1951 in order to increase the egg-grading capacity of the plant. In 1956 the butter-making plant was closed but the creamery continued to operate into the 1980s.

Erickson Creamery: Built in 1907 by Andrew Hanson, the creamery began operating in 1909. It closed in 1911 and until 1918 the building was used as a grain-crushing plant. In 1918 Anton and Sofus Christianson purchased the plant and operated it as a creamery until 1934, when Anton Christianson moved the equipment to Minnedosa where he had purchased a creamery. The building was never used as a creamery again. In 1935 Newman Hall Sr. and his family came from Rapid City and built a new creamery, named Lake Lands creamery. A busy day would see three hundred cream cans unloaded at the enterprise. In 1939 Ed Fotheringham of Brandon purchased the Lake Lands Creamery, as part of his Brandon Creamery and Supply company. It was sold to Manitoba Co-op in 1943. It was closed in 1974. During the 1940s the Erickson Creamery won many awards for its butter and high sanitation standards.²⁷⁴

Eriksdale Creamery: Two plants were operating here after 1912. One was owned by Brandon Creamery and Supply (Ed Fotheringham) who sold it to Manitoba Co-op before 1945. The other, operated by the Co-op from 1917-21, was purchased by Russ Casselman who operated it until his death in 1941. His son, Ivan sold it to Dan McFadyen and Chris Halldorson in 1948. By 1951 the creamery was combined with a locker plant operation and called Eriksdale Creamery and Locker Limited after 1951. A branch was opened in Moosehorn in 1958. In 1969 T.I. Gibbings purchased the Eriksdale Creamery. As small creameries disappeared, and local milk supplies decreased, Gibbings began to do butter printing and wrapping for other creameries. Then he switched to a butter-cutting facility, importing butter from other countries, cutting it and supplying a number of large retailers. In 1984 he retired and sold the plant to Ken Bjornson. The creamery was closed in 1990.

Fisher Branch Creamery: Operating before 1934. First managed by E. Cuipak and then Ivan Casselman after 1941

Flin Flon Dairy, Flin Flon: Operating in 1947. Sold to Modern Dairies in 1953

Foxwarren Creamery: Opened 1898. Still operating in 1911

Framnes, North Star Creamery: Operating in 1911

Fraserwood Creamery: Often won the "Best kept Creamery" award under H.E. Percival. Plant later owned by Richard Bjornson.

Frechette's Dairy, The Pas: Operating in 1947. Sold to Modern Dairies in 1956. (See Milk Plants)

Gallagher's, Winnipeg: Operating in 1936

Gardenton Creamery: Bought by Fred Askholm in 1933 and Mike Bednar in 1945. Closed in 1960

Gilbert Plains Creamery: Built in 1912 by G.D. Hudson. It was operated from 1918-1925 by Holland Creameries and then by Brandon Creamery and Supply. It was bought by Manitoba Co-op in 1943 and closed in 1967.

Gimli Creamery: Opened around 1900. Purchased by Modern Dairies in 1950s

Gladstone Creamery: Operated from 1895-1912 by H. Morton. Burns and Co. reopened the creamery in 1927. With the economic downturn in 1929 the Burns Co. decided to close the creamery. John Paxton, an agricultural college student who had been working as a cream grader for the summer, purchased it. From 1930-1936, as prices plunged, Paxton struggled to keep the business afloat. Not only did butter production increase dramatically, but the creamery also won the Grand Championship for butter at the Toronto Royal Winter fair for 1934 through 1936.²⁷⁵ In 1935, Paxton added egg breaking and grading and poultry processing to the venture, and modernized the old creamery with a new stainless steel churn. The plant was sold to Modern Dairies in 1966 and closed in 1974.

Glenboro Creamery: Opened in 1902 by the National Creamery. Bought by Canada Packers in 1944. Sold to Manitoba Dairy and Poultry Co-op in 1966

Glenella Creamery: The Ukrainian settlers in the Glenhope and Sunville districts produced a lot of cream but could really only ship it by rail in the winter. Needing a processing plant nearby, the community sent representatives to Winnipeg who persuaded the Peoples Co-operative Limited to start a creamery branch in Glenella in 1938. A lot of cream was shipped by train to the creamery. In 1941 the creamery was sold to Dominion Poultry Sales of Winnipeg, who sold to Manco in 1943.

Golden Star Creamery, Winnipeg: Operated by M. Katz from 1920-1922

Gordon Iron Side & Fares Co., Winnipeg: Operating in 1936

Greenberg, Winnipeg: Operating in 1930. Became subsidiary of Crescent Creamery and then was closed in 1936. Abe Greenberg and some of his staff joined the People's Co-op.

Grunthal: City Dairy Ltd. purchased the old Grunthal Milling Co. in 1927 and converted it into a creamery. This was purchased by Modern Dairies in 1956 and renamed Medo-Land Dairy Products. In 1958 Modern Dairies installed a milk powder plant here, the first in western Canada. The plant also produced butter.

Hamiota Creamery: Leased to A.A. Jory in March 1898

Hartney Creamery: A company of farmers and businessmen was formed and shares sold to finance the building of a modern creamery, which opened in March 1913, with Mr. Kenny in charge. Farmers increased their dairy herds and during its first year of operation the creamery

produced 64,000 pounds (29,091 kg) of butter. During the first World War, a manpower shortage and the high price of wheat, caused a reduction in dairy herds. After the War farmers did not return to dairy production and the creamery closed in 1921.²⁷⁶

Holland Creameries, Winnipeg: Operating in 1920 with branches in Winnipeg, Manitou, Virden, Somerset, and Gilbert Plains. Purchased by Ed Fotheringham of Brandon in 1923. He sold all his creameries to Manitoba Co-op in 1945.

Home Dairy, Winnipeg: Started by Mr. Barimbaum in 1926, sold to A Greenberg in 1928 and to Crescent Creamery in 1930. Operating in 1947

Ile des Chenes: A local cheese factory on NW26-8-4E was purchased by Crescent Creamery in 1916 and turned into a creamery. Unhappy with the prices paid by Crescent, farmers shipped their cream by railway to Winnipeg, forcing the creamery to close after World War I.

Inwood Creamery: Building was originally Narcisse Creamery. It was moved to Inwood in 1918. The creamery was purchased by Tom Elliot of Dominion Creamery, who ran it from 1922-29 before selling it to A. Phillips and Son, who marketed the butter out of their Winnipeg firm, Winnipeg Cold Storage. Stanley Phillips managed the facility from 1950-1965.

Killarney Creamery: Opened by Crescent Creamery in 1916, it burned in the 1920s and was rebuilt. It was sold in 1943 to R.A.S. Follett and to J.M. Shewfelt in 1952. The latter installed pasteurizing equipment for bottled milk. Sold to Modern Dairies in 1969, the facility was closed in 1970.

Lakeland, Selkirk: Went out of business in 1980s

Lundar, Maple Leaf Creamery Co.: Was a co-operative formed by local Icelandic farmers in 1901. Sixty shareholders provided the money to build a creamery on Mike Halldorson's farm. Later the building was moved to the Main Street of Lundar. The creamery, with equipment purchased from a creamery in the west, opened in April 1902. For the first six years the creamery operated for 4-6 months during the summer, producing approximately 13,000 pounds (5909 kg) of butter monthly. Often the farmers netted two to four cents more for their butterfat than they would have received from larger companies. The co-operative creamery was sold to Gudmundur Breckman and his son in 1931. The family operated the creamery until April 1975, by which time milk contracts had replaced cream shipping. Grimur Sigurdson was one of the butter makers at the plant for over 35 years. He won prizes for his skill as a butter maker every year, gaining the prize as "Butter King" in 1953. The creamery also won national prizes.

Macdonald Creamery: Opened around 1896

MacGregor Creamery: Opened around 1900. Another built in 1917. Owned by T. Eaton's Co. Closed in 1940

Makinak: Called the Northern Manitoba Creamery, the creamery was owned by a Mr. Draulans, and was located where the Makinak Roman Catholic Church was later built. It was operating in 1911 and was closed by 1927.

Manitoba Creamery Company: Operating in Winnipeg in 1920

Manitoba Dairy & Cooperative Dairies Ltd. (Manco): Incorporated in 1920 because farmers were having difficulty dealing with the very low cream prices paid by creameries. The Cooperative first purchased the Manitoba Creamery Company, engaging its manager, Alex McKay, as general manager. McKay was also President of the Manitoba Dairy Association from 1917-1921 and remained active in the dairy industry for years. The presence of the Co-operative caused a price war in the cream industry, and although this did not allow a profit for the Co-operative, they weathered the storm. The Co-operative in 1922 started a policy of issuing cash tickets for each can of cream collected, as opposed to the old policy whereby private companies paid cream shippers twice a month. The new business brought an increase in profits for the Co-op, which returned it to its members as dividends. The Co-operative also lobbied hard to make cream grading compulsory. In 1923 the Manitoba Poultry Marketing Association merged with the Manitoba Co-op Dairies. And in 1927 the co-operative started an expansion program, purchasing Crescent Creamery plants in Brandon and Dauphin as well as Gilbert Plains. In 1943 Glenella and Erickson creameries were purchased, but it was the purchase of the Brandon Creamery and Supply Company from Ed Fotheringham in 1945 which really expanded the company's facilities. Besides creameries in Miniota, Brandon and elsewhere, the deal gave the Co-op a fluid milk and ice-cream plant, a cold storage and locker service, a poultry-killing plant and an egg-grading station, all in Brandon. The next year the Co-Op added the Sterling Creamery plant in Brandon to its holdings. A new plant was erected in Swan River in 1957, followed by the acquisition of the Rapid City Creamery. From its new head offices in Winnipeg, the Co-operative's next major move was to seal the market in western Manitoba by purchasing the Smellie Bros. chain of creameries (Russell, Roblin, Rossburn, Shoal Lake, and MacNutt, Saskatchewan) for \$400,000. Manco, as it became known, now controlled 25% of the province's butter output, with total dairy product sales of \$5.5 million. Further purchases included the Cruise Dairy plant in Dauphin, Moundview plant at Pilot Mound, as well as construction of new cheese plants in Winkler, Rossburn and Dauphin. Manco was taken over by a Saskatchewan-based co-op in 1989.

Manitou Creamery: Operating in 1911. Owned by Reg Follett who sold it Canada Packers in 1942. It was closed in 1977.

Maryhill Creamery: Opened in 1902; moved to Lundar

Melita Creamery: An association of farmers built a creamery in 1912 but its lack of success caused the enterprise to dissolve and sell the business to Charles Shannon. He sold it to the T. Eaton Company in 1919. In 1927 a truck was used to haul cream from Lyleton. Five other routes were added: Fertile-Lyleton, Lyleton-Coulter, Pipestone-Reston, Grand Clairiere-Maple Hill. In January 1929, an addition was put on the north end of the creamery, to serve as an ice house. In fall 1929 another addition was put on the south end to hold the testing area, the washing equipment and the receiving apparatus. A large septic tank, to purify wastes, was added the next year. The plant was electrified in 1935, and artificial refrigeration was installed in 1937. Canada Packers took over the plant in 1940. In 1935 egg grading, and later poultry grading were added to the operation. Modern Dairies bought the plant in 1966. The creamery was sold to Doug Davis and Wayne Webster in 1977. The business was closed in 1982. In its years of operation it had produced over 10 million pounds (4,545,455 kg) of first quality butter, much of it for export, and won many major awards²⁷⁷

Miami Creamery: Built in 1912 by T.H. Rumball; sold to Martin Ohlson in 1932. The equipment was taken to Somerset Creamery when it was rebuilt.

Minnedosa Creamery: Opened in 1895, and made 150,000 pounds (68,181 kg) of butter in 1899 season. The creamery was managed by Hans Nelson during the early 1900s and may have closed in 1908. In 1930 Anton Christianson purchased the creamery and increased its butter production. In 1937 Chris Anderson bought the enterprise, selling it in 1939 to the People's Co-operative Limited of Winnipeg. Operations were expanded to include milk pasteurization, ice cream pasteurization, and home delivery. The pasteurization equipment was sold in 1941 and thereafter all the products delivered in the area were manufactured in Winnipeg. The Minnedosa plant produced butter which it shipped to Winnipeg. Later the pasteurization equipment was reinstalled until it was removed in the 1960s. The creamery picked up cream from Basswood, Clanwilliam, Bethany and Minnedosa farmers. The CPR daily service brought cream from Saskatchewan farmers as well. In 1951, faced with competition from the Brandon Pure Milk Company, who were picking up milk sales in the Co-op's collection area, the People's Co-op applied to the Milk Control Board for milk control in Minnedosa but were refused. In the 1960s, when the CPR service was discontinued, the creamery needed to increase its number of cream shippers. To do this, it offered a cream bonus and this resulted in a considerably wider collection area. New truck routes were added to Sandy Lake, Elphinstone, Inglis, McAuley, Hamiota, Oak Lake, Souir, Glenella, Riding Mountain, Neepawa, Rossburn, Erickson, and Shortdale. While butter production increased, the creamery lost its competition battle over milk and discontinued milk pasteurization and delivery. Concentration on butter production became the main enterprise of the creamery. In 1994 the enterprise became part of the Dairyland chain and the plant was closed.²⁷⁸

Miniota Creamery: Opened in 1931 and owned by Brandon Creamery and Supply Co. Sold to Manco in 1944 Closed in 1965

Modern Dairies, Winnipeg: Under the management of A. de Cruyeniére, this company operated 12 milk routes across Winnipeg and St. Boniface during the 1920s. In May 1931 J.W. Speirs purchased Modern Dairy and in 1932 added the St. Andrew Dairy to the company. The company now had a good wholesale milk system as well as a processing plant where it began to manufacture ice cream. In 1933 Modern Dairies became the first dairy in North America to market its ice cream in a grocery store, when the company formed an association with Canada Safeway.²⁷⁹ Over the next ten years the company purchased Standard Dairies Ltd., St. Boniface Creamery, Perfection Creameries, and Central Dairies. Before the Second World War, Modern had gone into truck delivery but the shortage of gasoline in the war forced them to go back to horses. They needed three trucks to operate properly so manager, Jim Speirs went to Ottawa to see C.D. Howe, Minister of Supply, who gave him authorization for the trucks. Between 1946-1956, the following dairies and creameries were brought under the Modern Dairies banner: Morden, Tolstoi, Flin Flon, Wheat City Dairy, Brandon Pure Milk, St. Claude, Frechette's Dairy at The Pas, and Crescent Creameries plants in Portage la Prairie and Swan River. They also purchased the Kraft Foods cheese plant at Grunthal. They also bottled milk for Winkler Creamery, Cambridge and Royal Dairies. These acquisitions gave the company plants in all parts of the province, and made it the largest privately owned dairy company in Manitoba, before Beatrice Foods of Chicago purchased it in 1970. Sven Jensen, previous owner of Carman Creamery and former manager of Crescent Creameries, was appointed President and General Manager in 1977. Under his regime, the Modern Dairies operated 130 fluid milk retail and wholesale milk routes, manufactured butter, ice cream, cheddar cheese, cottage cheese, instant dry skim-milk, and other by-products, serving a territory from Hudson Bay to the American border and from western Ontario to Saskatchewan border. The Modern Dairies logo has since been replaced by the Beatrice label, but the company's share of the market remains strong. In recent times an international company, Parmalat, has purchased the company.²⁸⁰

Moosehorn Creamery: Burned in the 1920s and was rebuilt in 1923 by H.J. Tattleman. Purchased by Alf Cuthbert in 1938 and transformed into a cream-buying station for Ashern Creamery in 1967.

Morden Creamery: Opened 1912 by E.D. Kirby. In 1928 Anderson and R.B. McKennitt purchased it. McKennitt operated it from 1938-1954, when it was destroyed by fire. Rebuilt in 1940, it was purchased by Modern Dairies in 1954. A modern building was constructed in 1972.

Morris Dairy, Morris: The Breyfogle family, who had a large Holstein herd at Union Point were instrumental in establishing a creamery in Morris in 1947. After the 1950 flood destroyed the creamery building, a new creamery was built on the main street of town, in combination with a soft ice-cream business. The creamery probably closed in the 1970s but the ice cream parlour was a big success and remained into the 1980s.

Moundsvew Creamery, Pilot Mound: Made 60,000 pounds (27,273 kg) of butter during summer 1898. Purchased by Manco in 1960s

Mutual Creamery, Winnipeg: Operated by Archie Mihalko from 1926-1927

Narcisse Creamery: Operated between 1918-1927. Bought by Brandon Creamery and Supply in 1923. This building was moved to Inwood after 1927 to become the Inwood Creamery. The equipment was taken to Elkhorn Creamery. Owned by Ed Fotheringham who sold it to Manitoba Co-op in 1945

National Creamery, Winnipeg: Opened in 1900, the second creamery in Winnipeg. Established on Logan Avenue by J.M. Carruthers and John N. Logan. Still functioning in 1904, with creameries in Winnipeg, Glenboro, and Gladstone

Neepawa Creamery: The first creamery opened in 1897. Laurentia Creamery opened in Neepawa in 1913. The company intended to produce butter, cream, and milk with a "long life" that would keep without refrigeration. The product was intended to be marketed to steamship companies. The inadequate milk supply in the district combined with the advent of mechanical refrigeration at the time, and poor management, led to the company's folding within thirteen months. The building was sold to E.P. Boyle, operator-owner of the Shellmouth Creamery, in 1916. He transformed it into one of the biggest creameries in the province, making over a million pounds (454,545 kg) of butter annually. Besides high quality butter, the plant also made ice cream. Neepawa National Velvet Ice Cream was shipped to towns all over the Parkland region. The cream came by train from areas as distant as Swan River, Rorketon, Angusville, Katrime and Westbourne. In 1923 Fred Clark began the first cream truck route and transport trucks stopping at farms gradually replaced rail service. The company used the refrigeration system it had inherited from the Laurentia Company, which required daily refills of block ice, until 1955. The Boyles expanded the business in 1933 by acquiring a creamery in Brandon, which became the Central Creamery. The Neepawa Creamery remained in business into the 1980s as an independent creamery. Today it is operated as Schwann's.²⁸¹

Newdale Creamery: Started 1895 by A.R. Fanning. Output for 1899 was 77,000 pounds (35,000 kg). A new building, 30ft. by 70 ft. was built in 1899. Closed around 1910 and the building torn down by 1913.²⁸²

Ninga Creamery: Sold in 1903

North Norfolk Creamery: Run by John Hettle, located between Austin and MacGregor in 1897. Later moved to MacGregor

Notre Dame Creamery: Opened in 1920 and was managed by Victor Robataille from 1930-1946. Marcel Boulic purchased the creamery in 1947 and operated it until 1964. Still operating in 1970

Oak Lake Creamery: Started 1895, by local shareholders and managed by W.J. Helliwell, on the western edge of town. It was closed in 1905, and sold at auction in 1910.

Oak Point: Creamery operated here by W.H. Green in 1920

Otterbourne: Creamery here in 1920

Palm Dairies, Winnipeg: Owned by Burns and Company, this was a large butter and ice cream business on Logan Avenue, until Modern Dairy bought it, and closed all but the ice cream division.

People's Co-op, Winnipeg: Organized as Workers & Farmers Co-operative Association in 1928, as a co-operative dealing in coal, wood, paint and feeds. In 1931 the organization expanded to manufacture dairy products and deliver milk to homes. Farmers had their cream picked up within a 100-mile (160-km) radius of Winnipeg and brought to a plant in Winnipeg for processing. Although the Co-op started out only selling milk and cream, it soon expanded to buttermilk, sour cream and cottage cheese, all important products for its Eastern European customers. At first butter was bought from other plants and cut and wrapped at the Co-op plant at the corner of Dufferin Avenue and Henry Street, but in 1934 the firm could finally afford butter-making equipment and it soon became famous for its high-quality butter. In 1936 it began producing cream cheese from a recipe brought from Switzerland by the plant manager, John Krall. By 1940 it was producing ice cream as well. The Co-op had home delivery service in the North End and then Transcona and North Kildonan and the inner city. They also sold their milk in corner stores all over the city. In 1936, when Home Dairy, a north end subsidiary of Crescent Creameries, was closed by that company, the former manager, Abe Greenberg, and five former drivers from Home were hired by the Co-op, bringing 600 customers with them. In 1938 the Co-op opened the Glenella Creamery and in 1939 added the Minnedosa plant. The name was changed to People's Co-operative Limited and the creamery department in Winnipeg expanded. In 1958 the Co-op started selling milk in Neepawa, Brandon, Falcon and West Hawk lakes, Lac du Bonnet, Great Falls, St. George, Powerview, Grand Beach, Seven Sisters, Whitemouth and Rennie. William A. Kardish was the general manager for over fifty years. In the 1980s the co-operative still manufactured a full line of dairy products and had a fleet of 75 trucks for delivery and pick-up. Partial deregulation of milk prices in 1989 put the Co-op in jeopardy. It was then the only Manitoba-owned dairy-processing plant in Winnipeg. In 1990 Co-op and Dairyland were the only two dairies who employed their own delivery personnel. In October 1992, the Co-op sold its creamery to its employees, known as Dufferin Employment Co-operative Limited. Within two years they were taken over by the British Columbia based corporation, Dairyland, who closed the old dairy building.²⁸³

Perfection Creamery, Winnipeg: Located on Sherbrooke Street, it operated from 1929-1955. Modern Dairies bought it in 1946.

Piggly Wiggly Canadian Co. Winnipeg: Operating in 1934, as Sundale Creamery. After 1969 no longer manufactured butter but still cut and wrapped it.

Piney Creamery: In 1948 Fred Askholm and his family opened a creamery in Piney, with the promise of 500 dairy cows to supply the cream. In February 1949 the creamery began producing butter under the Tasterite label, and it was sold in local stores. The creamery truck picked up the cream at the farmers' gates twice a week, at the same time delivering the cream cheque from the previous pick-up. In 1951 the creamery's power supply was converted from steam to electricity. The Piney Creamery was destroyed by fire in 1953.

Premier Creamery, Winnipeg: Owned by R. Barbour from 1912-1915

Portage Creamery, Portage la Prairie: Operated from 1933 - 1948 by Alex Rey, who made butter and sold milk to Portage la Prairie customers. Sold to Crescent Creamery in 1955
Closed in 1966

Ranchvale: Birdtail Stock Company opened a creamery on SW36-20-25W in 1895. Angus Grant was the butter maker and the power was created by a three-horse treadmill. The creamery had a herd of 40 cows that were milked to provide the cream for the enterprise.²⁸⁴

Rapid City Creamery: Organized as joint-stock company in 1891. Output for 1899 was 72,000 pounds (32,727 kg). There was trouble from the beginning with the operation of the creamery and it was closed sometime before 1915, when the decision was made to lease it to T. Eaton Co., with the option to buy it. Purchased by Canada Packers in 1940 Purchased by Manco in 1957. The plant was inspected and condemned. The building was demolished in 1965.²⁸⁵

Reaburn Creamery: Opened in 1898 by James and Paul Tully on 12-13-4W, west of Reaburn. Milk for the creamery came from their own herd of Jersey cows. The butter produced at the creamery was shipped daily to Winnipeg. Ice to keep the product cold was taken from Long Lake.

Red Valley Creamery: Operated by John Cuipak in 1924 and 1926. Closed in 1927

Reston Creamery: The idea of a creamery had been first suggested in 1924, but only when C.W. Paddock returned from the war in 1946 did the dream become a reality. Paddock built a building 40-50 feet (12-15 m), south of the railway tracks and accepted the first cream in July, 1946. Under the name "Bonnie Brae" he produced 12 million pounds (5,454,545 kg) of butter in the old wooden churn before replacing it with a stainless steel churn in 1964. Once grain prices rose, people reduced the number of their milk cows and business gradually fell off until 1966, when the creamery was partially closed, serving only as a receiving station for Souris Creamery. The creamery closed shortly afterward.²⁸⁶

Rivers Dairy, Rivers: Operating in 1947. Purchased by Modern Dairies in 1950s

Riverton Co-op Creamery: Originally opened by S Thorvaldson and Co. in 1897 as the Lake Winnipeg Dairy Association. Cream pick-up service was initiated in 1898. The creamery closed in 1915. In 1925, W.G. Rockett, who had moved to Riverton in 1917, was a founder and director of the Riverton Co-operative Creamery.

Rosburn Creamery: In 1902, the former cheese factory building was converted into a creamery by Hough and Wickware who produced butter there. The location, about 5 km south of Rosburn, was changed to north of Rosburn. A new plant was installed there with George Kelso as butter maker. Hough Bros. sold the plant to the Smellie Brothers in 1924, and it was closed. In 1946, Smellie Bros. opened a new plant in Rosburn, which was sold to Manco along

with the entire Smellie chain in 1960.²⁸⁷ The people of Rosburn were able to influence the Co-op to build a new plant in Rosburn, where cheese could be produced as well as butter. The new Manco plant began receiving milk in December 1968. The new Manco plant began receiving milk in December 1968. In 1978 the butter and cheese functions were combined in one building.

Roblin Smellie Bros. Creamery: This creamery was built in 1934 as part of the chain owned by the Smellie Brothers, A.G.P and his brother, Dr. T.S.T. Ably operated by John Collins and his butter maker, Ron Vaudry, the Roblin Creamery continually won awards for its butter. The Smellie chain was sold to Manitoba Co-operative (Manco) in 1960. The plant still churned butter in its 1600-pound (725.76-kg) steel churn in the late 1980s.

Royal Dairies, Winnipeg: Operating in 1947

Russell Creamery: Built in southeastern Russell in 1898 by Lawther and company, the creamery shipped its first butter in May 1898, produced 36,000 pounds (16,330 kg) of butter that year, and also won second prize for its butter at the Winnipeg Fair. Its patrons were paid 13 7/8 cents per pound (31 cents per kg) of butterfat. Although the enterprise seemed to be very successful, its operations were handicapped by the lack of a cold storage facility. The manager, Mr. McCamon, purchased ice to establish an ice house in 1899. The following year, McCamon skipped town with the creamery's money. The creamery tried unsuccessfully to carry on under new management. Its former patrons took their cream either to the Barnardo Home Creamery or the Shellmouth Creamery. In 1903, the creamery machinery was sold and shipped to British Columbia.

Safeway Lucerne Dairy, Winnipeg: Safeway, an American grocery firm, entered the Manitoba market in the 1930s, and used milk as a loss leader. The firm set up supermarkets where the consumer could purchase everything from dairy products to fresh fruit and vegetables, driving many of the small stores out of business. At first, Safeway only produced its own milk and ice cream, buying its butter from Lakeside Butter Company. After 1980 the firm produced its own line of dairy products under the Lucerne label.

Ste. Anne: A creamery, or at least a butter factory, existed in Ste. Anne during the 1930s. It was owned by Eugene De Montigny, and run by his son, Joseph.²⁸⁸

St Boniface Creamery Co. St. Boniface: Started by Charlie Gaudet in 1913. Built a subsidiary creamery in St. Claude in 1920 Sold to Modern Dairies in 1936

St. Claude Creamery: In October 1920, St. Boniface Creamery opened a plant in the French-speaking community of St. Claude. The creamery became the property of City Dairy in 1925 and was resold to a local family, the Bazin brothers, in 1930. Its reputation for high-quality butter allowed the plant to survive even the Depression, and continue to buy cream from the district's mixed farmers. In 1949, the creamery burned and was replaced by a new larger, modern plant. Aware of the trend towards bulk milk sales, the plant owners, backed by the local Chamber of Commerce, and the St. Claude Agricultural Society, decided to open a dry milk plant. The idea must have been a good one because very soon Modern Dairies approached the owners to buy the existing plant. Construction of the dry milk plant began in 1966. It opened in early 1967. The plant became the property of Beatrice Foods in 1970. The plant was valued at \$2.5 million in 1974 and that year it produced 4,565,650 pounds (2,075,295 kg) of skim milk powder, 2,277,532 pounds (1,035,242 kg) of butter, and 217,450 pounds (98,841 kg) of buttermilk powder. Today, Parmalat operates the plant.²⁸⁹

Ste. Genevieve: Operating in 1920

St. Francois Xavier Creamery: H. Hubert established the first butter factory here in 1885. It manufactured 150 pounds (68 kg) of butter daily and charged farmers five cents per pound (11 cents /kg) for manufacturing it. A second cream separator, hollow bowl type, was put into use September 1885.

St. George's Creamery: Operating in 1947

St. John's Creamery, Winnipeg: Opened by T. Cuipak in 1920. Closed in 1931 and equipment sold to E. Greenberg and Son

St. Joseph's Dairy, Winnipeg: Operating in 1934 and in 1947

St. Lazare Creamery: Opened by Mr. Gaudette of St. Boniface in 1925. Bought by Smellie Bros. of Russell in 1933. The development of a large community pasture at St. Lazare during the Depression cut off the local cream supply, and the St. Lazare plant was closed in 1945. After the Second World War, the company built a new creamery in Rosburn to replace this plant.

St. Malo: Condensed milk factory opened in 1897, with the product shipped to Japan and China. Butter maker, M. La Borderie shipped butter to Japan in 1890. Operating in 1920

St. Pierre Creamery: S.M. Barre established this creamery in 1886. Another factory established in the 1930s, which Albert Prefontaine, later Manitoba Minister of Agriculture, helped build this plant and where he worked for two years. Three separators separated the 20,000-30,000 pounds (9,091-13,636 kg) of milk received annually.

Ste. Rose Creamery: A cheese factory, built here in 1900, was converted to a butter plant in 1908 and operated by the Maillard family after 1910. A new plant was built in 1916 and again in 1956.

Shamrock Creamery, Goodlands: Opened for two years between 1914-1916

Shellmouth Creamery: Opened for business in June 1898. Output for 1899 season was 40,000 pounds (18,182 kg). Operated by E.P. Boyle in 1920 Bought by Smellie Bros. of Russell in 1923

Shoal Lake Creamery: Built in May 1889 by Robert Scott, this was the first real creamery in Manitoba. The Smellie Brothers acquired it in 1904, the first in their chain of creameries. In 1928, the old building was replaced with a new brick and concrete structure. Ice cream manufacture was started at the Shoal Lake creamery and later centralized there. In 1952, a fluid milk plant was added to Shoal Lake. In 1960, the chain was sold to Manco. Continued to operate until 1967

Simpson Produce, Winnipeg: Operated from 1913-1914 by Kelly Simpson

Smellie Brothers Limited, Russell: A.G.P. and Dr. T.S.T. Smellie, successful merchants in Russell and Binscarth, purchased the Shoal Lake Creamery in 1903. The success of the business led them to open a new creamery in Russell, which had been without a creamery since the Barnardo Home closed in 1906. A new building was erected near Memorial Avenue

and Darcy Street, opening in June 1916. The war created a demand for dairy products and the creamery boomed. In 1917 the creamery received a 100% grade from Department of Agriculture inspectors, the "only time that such a percentage has been received by any creamery in the province."²⁹⁰ The creamery continued to win national awards, often losing to its sister creamery in Shoal Lake. The Smellies added other branches to their company: Shellmouth, Rossburn, MacNutt, Saskatchewan, St. Lazare and Roblin. In 1959, the Manitoba Dairy and Poultry Co-op purchased the Smellie chain. The Russell Creamery was closed in November 1967 and the building was demolished in October 1968.

Solsgirth Creamery: Opened in 1902

Somerset Creamery: A creamery at Somerset was sold to Georges Arnould in 1907. Later it was rebuilt with equipment from Miami Creamery. It became part of Holland Creameries in 1920 before Ed Fotheringham of Brandon Creamery and Supply purchased that firm in 1924. The creamery processed 40 cans of cream daily. Martin Ohlson purchased the creamery in 1927. In May 1937, a fire completely destroyed the building, but Ohlson rebuilt it with more modern equipment. It was sold to Yves Rocan in 1948 and then by Maurille Rocan in 1961. Somerset Creamery was noted for its high quality butter. Creamery trucks picked up cream from farmers in the Pembina Hills region, as far west as Baldur and Crystal City, and as far east as Treherne and Darlingford. One to two thousand pounds (454-909 kg) of butter were churned daily and delivered to Winnipeg. In 1972, Rocan's widow sold the creamery routes to Notre Dame Creamery, the churn to Inwood Creamery, and the building was converted into a garage by her son.

Souris Creamery, Souris: Originated in 1897. Creamery closed in 1902 due to business losses. Reopened in 1913 as a joint stock company, managed by C.C. Curtis and operated successfully as a butter plant for 38 years. Canada Packers purchased it in 1951. The company introduced milk-pasteurizing equipment but the milk produced in the area was never of a high quality. The plant was sold in 1956 to C.W. Paddock of the Reston Creamery. He also tried to produce cheese there, as well as introducing waxed cartons for the milk. The creamery burned in 1959 and was rebuilt soon after. The plant produced cottage cheese, ice cream and a new type of Danish cheese called "Ambassador." The plant closed in 1968.²⁹¹ It was later purchased by Sapoto Inc. one of Canada's largest cheese producers, who operated it until 2002, when they transferred its functions to their Winkler plant. Sapoto's purchase of Dairyworld in 2001 brought about a further rationalization of the cheese-making industry.

Standard Dairies, Winnipeg: Operating in 1934. Sold to Modern Dairies in 1935

Sterling Creamery, Brandon: Operated by A.L. Pearson from 1934-38. Sold to Manco in 1953 and closed in 1956

Steinbach Creamery, Steinbach: Purchased by Kraft Foods in 1946. Later owned by Crescent Creameries

Stonewall Creamery: Opened around 1900

Sundale Creamery, Winnipeg: Opened in 1936 by Piggly Wiggly. As Lakeside, it produced the butter for Safeway stores. After 1969 it no longer manufactured butter but continued to cut and wrap it.

Swan River Creamery: A creamery company was formed in 1908 and obtained property on what is now Park Drive. The plant operated from 1909 to 1922, when Crescent Creamery acquired the creamery. A new site was chosen, west of the railroad. In 1929, the creamery instituted a pick-up service for cream. By 1932, the cream trucks were hauling from all over the valley, on a twice a week pick-up for each point. An average load in 1938 was sixty cream cans, plus twenty crates of eggs. Creameries in Norquay, Winnipegosis, Canora and Dauphin offered competition to Swan River and drays were delivering cream from the valley to these other creameries. In 1964 the creamery was destroyed by fire and a small storage and distribution centre was built. The Crescent Creamery was sold to Modern Dairies who closed the small distribution centre in 1984. The Swan Valley Co-operative Creamery was built in 1957 and continued to operate in a limited capacity into the 1980s. A cream shortage caused Manco to close this operation.

Swift Canadian Company: Purchased the J.Q. Gallagher creamery (1926-1934) in Winnipeg in 1934. Also had plants in Dauphin (1926-1948), Neepawa (1933-1966), and Winnipeg (1924-1950). The Dauphin plant was sold to Canada Packers around 1950 and closed in 1967.

T. Eaton Co., Winnipeg: Owned three plants, at Melita (1917-1940), Rapid City (1915-1940) and Winnipeg (established in 1908). These were sold to Canada Packers Ltd. in 1940.

Tolstoi Creamery: Owned by D. Uhryniuk from 1934-40 and by W. Kostyniuk during the World War II. Former staff members, Andy Skolny and J.F. Palamarchuk, purchased the plant after the war, but in 1953 sold it to Modern Dairies. The creamery was closed in 1960 because of an insufficient volume of cream.

Treherne Creamery: Built in 1912 but closed in 1914. Reopened in 1923 by City Dairy and partly used as a milk depot until 1928. In 1944, the creamery was reopened by Leo Magnusson, and closed in 1972 after his death.

Tungland, Brandon: Creamery operated by John Tungland in 1920

Union Milk Dairy and Produce Company, Beausejour: Established creamery at Beausejour in 1901. Burned in 1920s and replaced.

University of Manitoba, Winnipeg: Operating in 1947 into 1980s. Processed the dairy products from university farm into products used in the campus restaurants and dining rooms

Vita Creamery: Built by Crescent Creamery in 1919. Burned in 1923 and rebuilt same year. Run as a co-operative after 1939

Virden Creamery: Virden farmers were interested in establishing a creamery as early as 1895 but it was not until 1912 that a creamery company was formed by J.A. McLachlan and W.A. Bridgett. The creamery was a one and one-half storey building, with an icehouse, on Seventh Avenue. Brandon Creamery and Supply, owned by Ed Fotheringham, purchased the creamery in 1920. The output of the creamery for 1926 was 300,000 pounds (136,080 kg) of milk products. The creamery was sold to Dalton Powers in 1935. After his death, his wife carried on the business until 1975, producing ice cream and butter.²⁹²

Wakopa Creamery: Established in June 1885 by Wakopa Creamery Association, organized by John Hettle of Boissevain, with \$1000 capital and shares for \$10.

Western Ice Cream Co. Brandon: Operating in 1920

Western Produce Co. Winnipeg: Opened in 1914. Operating in 1936

Wheat City Dairy, Brandon: Operating in 1937. Sold to Modern Dairies in 1955

Winkler Dairy, Winkler: Started as a small creamery run by J. Coltart in 1922. Became a co-operative in 1940. The equipment from the Reinland Cheese Factory was transferred here in 1949 and the creamery began to produce cheese, as well as butter and ice cream. In 1957, a poultry-processing plant was added but over production of poultry caused it to cease operations in 1961. Likewise, the decrease in the amount of milk shipped to the plant cause the profits to decrease and the plant was turned over to Manitoba Dairy and Poultry Co-operative Ltd. in 1969.

Winnipeg Creamery and Produce Company: Opened in Winnipeg in 1897 with S.M. Barre as manager. In May 1898 Barre, started paying for cream on the basis of the Babcock Test, the first creamery to do so. Still functioning in 1920

Winnipegosis Creamery: Built in 1907, it was operated by the Armstrong Trading Company from 1908-19, then by Shears and White until 1948, and by Henry Hansen from 1949-1966.

CHEESE PLANTS

Some of these cheese-making operations may have been part of the local creamery. Earlier ones were likely stand-alone cheese plants.

Alexander: Established in 1894, but only functioned one year.

Argyle: Henry Last of Brant established a cheese plant on his property in 1892. It was supplied with power by a windmill. Last had a herd of 30 cows and manufactured both cheese and butter. His cream separator was run by a treadle. Butter was made during the winter and cheese during the summer. Last trained his daughters in cheese-making. The plant was still operating in 1899.

Arnaud: Opened in 1937, with Henry H. Janzen as cheese-maker. At the peak of production, 30,000 pounds (13,636 kg) of cheese were manufactured each month, and sold for 27 -30 cents per pound (60 cents per kg). The three workers at the factory did not receive a fixed salary but rather a commission of 3/4 cent per pound of manufactured cheese. When grain prices improved, farmers' interest in dairy cattle declined. The amount of milk delivered to the factory dramatically decreased and the factory closed after five years of production.

Arrow River: (See Parkissimo)

Aubigny: Benjamin Ladouceur operated a cheese factory at the bend in the Red River from 1907-1909. Another plant was in operation later, two miles south of the Aubigny-Silver Road.

Baldur: Opened in 1895. Closed in 1897

Balmoral: Ordered equipment for factory in July 1885

Barnsley: Opened in 1899 and closed in 1900

Bayer: Licensed in 1914

Benard: Cheese factory here around 1911

Beulah: Established in 1889. Closed in 1896

Binscarth: Opened in 1896, with manager, Fred Baker, and cheese-maker, George Delbridge, in charge. Built in Silver Creek valley with a grant from the Manitoba Government, the enterprise was unsuccessful and closed by 1900.

Birtle: Built by Dr. Meyer, it opened July in 1885

Blumenort: The first cheese factory operated from 1895-1917. In 1932, when the Depression caused the price of fluid milk in Winnipeg to plummet, the farmers in the Blumenort region formed a co-operative association to build a new cheese plant. Local farmers contributed labour to build the building, on a site donated by Peter R. Penner. To raise capital to operate the plant, shares were sold at \$10 each. Eighty local farmers contributed a total of \$1000, and Albert Carrier, an expert cheese-maker from Winnipeg, was hired to teach Cornelius Kornelson the art of cheese making. The factory opened in July 1932 and during its first full month of operation 76 farmers shipped 173,038 pounds (786,536 kg) of milk to the plant. Some shipped more than 4,000 pounds (1,818 kg) each. The cheese was sold to Winnipeg wholesalers, local stores and farmers for 10 cents per pound (22 cents/ kg).

The factory was such a success that milk shippers were soon receiving \$1.07 per hundred weight (45 kg) of milk. As shares rose in value, the co-operative struggled to find a new way to operate that kept the people who shipped to the plant in control. Instead of using shareholders' money to operate the plant, users of the facility had a certain amount of their milk money held back to use as operating capital. It was next modified to correspond to the number of cows a dairyman kept, rather than the amount of milk he shipped. In this way, farmers were encouraged to increase the productivity of each cow.

In 1946, Kornelson retired and was replaced with Cornelius Unger who had become a prize-winning cheese maker. At that time, the factory's production was at its height, producing 269,000 pounds (122,272 kg) of cheese annually. After World War II the factory began to experience problems because more farmers began shipping their milk directly to Winnipeg. In 1953, dwindling milk supplies forced the plant's closure, just as had occurred in 1917.

Boissevain: Turtle Mountain Creamery Association, in 1888, built a cheese plant which guaranteed patrons one pound of first-class cheese for every eight pounds (.5 kg per 3.6 kg) of milk brought in. The company was organized by John Hettle, MPP for Boissevain.

Brandon: Opened in 1898

Broad Valley: Functioning in 1920

Canada Packers: This company, with a head office in Toronto, began buying into the Manitoba market in 1940 when it purchased T. Eaton Co.'s plants at Winnipeg, Melita, and Rapid City. The Winnipeg plant was closed. In 1942, Canada Packers purchased a plant at Manitou, and also 1942 bought the creameries at Glenboro and Crystal City.

Carberry: Established June in 1893

Carman: In 1884, William Taylor opened a cheese factory in Carman which operated for two seasons before a lack of support forced it to close. A second factory was established by the manager of Headingley Cheese Factory, on Villiard Avenue in 1895. Again, a shortage of a steady milk supply forced it to close after two years.

Cartwright: Opened in 1895. Closed in 1897. Oscar Beach made cheese in his home for a few years in the 1900s.

Cayer: Located near Lake Manitoba, this cheese factory benefitted from the milk brought to it by cream boats from ranchers in remote settlements along Lake Manitoba. It was operating in 1913.

Clearwater: Burned in December, 1900

Crystal City: Opened in 1888 by Wm. Taylor. Purchased by Canada Packers in 1944. In 1951 the Swift Canadian plant in Dauphin and the Souris Creamery were added to the plants owned by Canadian Packers. In 1960 the company sold its cheese operations in Manitoba to Modern Dairies and Manco.

Dauphin: Swift Canadian sold its cheese plant here to Canada Packers in 1951, who sold it to Manco in the 1960s.

Deloraine: A joint stock company was formed by local farmers in 1894 and, with a guarantee of 300 cows, H.J. Rockett, of Manitou, agreed to be the cheese-maker at a factory in the region. The company was to supply the building while Rockett agreed to furnish the equipment, draw the milk and pay farmers three cents per pound (6 cents /kg) of cheese manufactured. The whey could be returned to the farmers if they paid 1/2 cent per pound (1 cent/kg). The factory was built on E27-2-23W and began operating in May 1894. There were five milk routes and on a good day, 11,500 pounds (5,227 kg) of milk could be collected. The first Deloraine cheese was offered for sale in local stores in June 1894 for 12 1/2 cents per pound (27.5 cents /kg). By the end of the summer it was available in towns across southwestern Manitoba. The factory produced 35,528 pounds (16,150 kg) of cheese from the 366,055 pounds (166,388 kg) of milk it collected. All but 150 were sold, at 9 1/2 cents per pound (21 cents /kg). The company increased its marketing efforts for the 1895 season, and even shipped 200 cheeses to Montreal to be sold on commission, as part of a carload gathered by CPR along its lines. The members were unhappy because so little of the cheese had been sold that they realized less than 6 1/2 cents per pound (14 cents/kg). Some cheese was sold to S. Barre in Winnipeg for bargain prices. Annoyed that the cheese had not sold, and unable to negotiate a more profitable deal with the cheese-maker, the patrons deserted the enterprise. Although Rockett tried to establish a business independent of the joint stock company, he failed. The cheese factory closed in 1897.²⁹³

Douglas: Started operating in June 1893

Dugald: Existed in 1887

Ebenfeld: (Near present-day Mitchell) Opened on SW8-7-6W in 1936 by Hanover Co-op Dairy Society, with George Cornelson as cheese-maker. It operated for nearly 20 years.

Fannystelle: Opened in 1899. Reopened in 1917 Still functioning in 1920

Giroux: Opened in 1900 and closed in 1907

Gladstone: Opened in 1890s

Glenboro: Sold to Canada Packers in 1944

Grand Point: Operated from 1904-1911

Greenwood: In Rockwood Municipality, opened in 1885

Greenland: (Near Steinbach) Opened in 1897 and closed in 1914

Grunthal: Opened in 1897 and operated for four years under Mr. Braun. Then it closed and was reopened in 1915, operating for three years as the Grunthal Trading Company. It was purchased by City Dairy in 1928 for butter and cheese making. This enterprise was unsuccessful so it was sold to Farmers' Co-operative in 1943, and to Kraft Company in 1945. Kraft closed the plant from fall 1954 to March 1955 due to a shortage of milk. The plant was sold in 1956 to Modern Dairies and renamed Medo-Land Dairy Products.

Hanover: Opened in 1936

Harperville: A. Sigdal operated a cheese factory here in 1924. Closed in 1935

Haywood: Factory operating here in 1920. Reopened in 1939

Headingley: Opened in 1895 but only lasted two years

High Bluff: A cheese factory in the Portage Creek area was opened in the 1890s. The milk was collected six days a week by wagon, which could hold 40, one-gallon (3.785-litre) cans. There were three milk routes with three collection carts. At the factory, the cans were unloaded by a pulley and track system, run by a stationary engine. The cheese-maker was Robert Oliver. The enterprise lasted for only a few years, but the building remained until 1977.

Hochfeld: Operating in 1911

Hochstadt: Opened in 1893 by Jacob Regehr. The factory was so successful that Regehr enlarged it and hired staff to help run the factory between May and October each year. In the 1900 season, the factory took in 292,098 pounds (132,271 kg) of cheese and sold 30,152 pounds (13,705 kg) of cheese at 10.5 cents per pound (23 cents/kg). Closed in 1912

Ile des Chenes: In 1897, a cheese factory opened on NW26-8-4E. In 1916, Crescent Creamery bought the building and converted it into a creamery.

Killarney: Opened in 1895. Closed in 1906

Kleefield: Factory operating here in 1911. Closed in 1920 Another opened in 1933

Kraft Foods: In 1945, Kraft purchased the Grunthal Co-op Dairy, replacing it with a modern plant in 1947. Milk was pasteurized and then turned into 10,000-pound (4545-kg) cheese vats. The plant was sold to St. Boniface Creamery in 1956 and then Modern Dairies Ltd. Kraft bought two other small cheese factories, one at Barkfield and one at Woodridge, as well as contracting

the cheese from several small factories during the war. Albert Ouillette, the former Cheese Inspector from 1946-1955, managed the Kraft Food Cheese division. The company eventually consolidated all its operations at Calgary and Montreal.

La Broquerie: Opened in 1898 and closed shortly after. A second factory opened in 1903 and closed in 1919. Another opened in 1935, a co-operation between the La Broquerie Co-operative and the Kraft Phenix. The relations between the board of the Cooperative and the manager of the factory deteriorated until the Co-operative purchased the Kraft equipment in 1939.

Landmark: Opened in 1932

La Riviere: Built in 1880s by H.J. Rockett on Mary Jane Creek

La Rochelle: Opened in 1902 and closed in 1920

La Salle: Established by M. Cormier in 1890s

Lauder: Opened in 1895, on south edge of 20-5-24, near the bank of a ravine. Daily pick-up of milk took place, with the whey returned to the farmers for pig feed. In 1897, when it closed, the manager was W. Brigden. There may have been a shortage of milk to support the enterprise.²⁹⁴

Letellier: Established in 1894

Lorette: The first Lorette cheese factory was established in 1896 by D. Pelletier, close to the Seine River, but it didn't last very long. In 1917, E.J.R. Arpin started another creamery in Lorette. Cheese-maker, Albert Carrier reported in 1916 that he had made 93,447 pounds (42,476 kg) of cheese that season from 966,612 pounds (439,369 kg) of milk. This factory appears not to have lasted very long either. In 1927, an Italian family opened a factory in Lorette in which Italian cheeses were manufactured. This factory burned down sometime between 1931 and 1934.

Manitoba Agricultural College: Opened a cheese plant in 1929

Manitou: Started in May 1888. Sold to Canada Packers in 1942

Marquette: Opened in June 1891, by James Robertson. Closed in 1912

MacGregor: James Bousfield operated a cheese factory south of town in 1898

Meadow Lea: Opened in 1888 and closed in 1909

Minnedosa: Opened in 1888 by A. Malcolm. In 1888 the factory machinery was moved to Dauphin.

Morden: Opened in 1888

Napinka: Opened in 1895. Closed in 1897

Nelson: Started in 1886, by George Cummings

New Bothwell: Opened in 1936, this factory survived the factory closings of the post-World War II period. Organized as the New Bothwell Co-op, the plant was modernized in 1954 with the installation of a De Laval high temperature, short time, milk pasteurizer, the first one in Manitoba. The co-op purchased equipment to package cheddar in square 40-pound (18-kg) blocks, and later created smaller square packages wrapped in "cry-o-vac". George Doan, the general manager, oversaw the construction of a new factory building in the 1970s. Equipped with natural gas, tiled floors, and walls lined with stainless steel, it has the ability to handle vast amounts of cheese. The plant also has drums in a separate building where the whey can be dried for sale as animal feed. There is also a large lagoon, at a distance from the plant, to handle wastes.

Newdale: Built in 1888 by David Jackson south of Newdale. Closed in 1890s²⁹⁵

Niverville: Opened in 1940

Oakbank: Located at Sunnyside, near Oakbank, it was opened in 1888 by Dr. Jamieson.

Oak River: Opened in 1895 and closed in 1896. The owner, Mr. Hess, had two milk routes along which milk was collected. He shipped a carload of cheese to Ottawa but the cheese was somehow lost and he never received any money for it, bankrupting him. He actually paid the farmers back by working as a labourer on their farms.

Oak Lake: Built by F.T. Luno in 1886. That year 40,000 pounds (18,182 kg) of cheese were made and sold at \$1.00 per pound (\$2.20/kg). Reorganized in 1890s by A. Tetrault.

Orange Ridge (near Neepawa): Began operations in 1896 on NE32-17-14W on the farm of David Wilson. Frank Harper was the cheese-maker. The factory switched to butter production, with Chester Walker as butter maker, and ceased operations by 1905.

Otterbourne: Opened in 1888 by Phil Carey. Closed in 1920 New one opened in 1935

Parkdale: Opened in 1889

Parkissimo: With butter and milk surpluses in Miniota Municipality, it was decided to open a cheese factory in 1895, on SE11-14-26W, with a government loan. Milk was brought to the factory from routes by horse-drawn vehicles by 10 a.m. On the route home the drivers returned whey to the farmers. Patrons received 65 cents per 100 pounds (45 kg) of milk, delivered. The delivery cost was 10 cents per 100 pounds (45 kg). The factory closed for the season each October. Part of the first shipment of cheese sent to England by S. Barre was from Parkissimo. The factory operated until 1898, then was closed for a season and reopened briefly in 1900. The building was sold in 1900.

Pigeon Lake: Operating in 1911

Poplar Heights: On NW3-13-3W, opened in 1898 by James Robertson

Poplar Point: Opened in 1895 and closed in 1898

Portage la Prairie: Built by George Cummings Opened in 1895

Rapid City: Opened in 1882 by Andrew Patterson, as the second cheese factory in Manitoba. The plant was closed when Patterson joined the forces to fight the North West Rebellion. James Hampton opened a second factory, in 1886, which manufactured 13 tons (11,818 kg) of cheese between May-November, 1887. The plant machinery was worn out by 1890 so the company switched to butter-making equipment.

Reinland: The Reinland Co-operative Dairy Society was formed in the Village of Reinland, in 1936, to find a solution to the surplus of milk produced in the area as farmers tried to deal with the Depression by diversifying their operations. The Co-operative opened the cheese factory in 1937, with John Unger as cheese-maker. By 1940 the cheese factory had produced 1400 pounds (636 kg) of cheese per season, much of it shipped overseas during the war. The machinery was transferred to Winkler Creamery when the factory closed in 1949.

Richer: Thibaultville cheese factory operating here in 1911. Another factory was operating from 1924-1931.

Ritchot: Opened in 1939

Rosenhoff: The Rosenhoff Dairy opened in spring 1940 as a co-operative with the sole purpose of manufacturing cheese. During the Second World War, 90-pound cheeses (41 kg), without colour, were produced. Approximately 2,000,000 pounds (909,091 kg) of cheese were made in this factory before the 1950 flood caused it to be closed. By then many of the contributing Mennonite farmers had moved to Mexico. The equipment from Rosenhoff was used to open a cheese factory in Mexico.

Rosburn: The first cheese factory was organized by farmers in 1887. The co-operative built the factory in a valley by a river where there would be sufficient pasture. Sixty to seventy cows were rented from farmers for the summer and men were hired to milk them. The factory operated for four years before moving to 13-19-25W, which was closer to the village. When the price of cheese fell, the company collapsed.²⁹⁶ Manco opened a cheese plant here in 1969. The new plant cost \$295,000 to build and was partially financed by the people of Rosburn. It produced eleven kinds of cheese. The cheese and butter plants were combined in 1978. The plant was closed in the 1990s.²⁹⁷

Royal: Opened in 1895 and closed in 1905

Russell: Opened in 1895 and closed in 1897

Sarto: Operating from 1909-1911

St. Adolphe: Opened in 1897 and closed in 1898

St. Agathe: Opened in 1888 by S.M. Barre. Burned in December 1900

Ste. Amelie: Operated from 1905-1908. Another operating from 1924-1932

Ste. Anne: Opened in 1895 on the south side of the Seine River. It was possibly operated by shareholders because Raymond Magnan was the secretary and Emile Dubois was the cheese-maker.²⁹⁸ The factory closed between 1905-08. In 1937, a representative from Kraft's factory at La Broquerie came to encourage the farmers in the area to start a new factory. A co-operative was formed and a building constructed. La Cooperative de Ste-Anne des Chenes opened July

14, 1937, and received 10,000 pounds (4,545 kg) of milk. In its first five months of operation the factory received over one million pounds (454,545 kg) of milk, paying producers \$1.04 per hundred pounds (45 kg). Georges Frechette was engaged as cheese-maker, and he won many prizes for his products. The cheese was sold to Kraft Canada, Swift Canadian and Burns and Co. In 1940, the factory suffered financial losses because a typhoid epidemic in the region brought the sale of cheese to a halt, on the orders of the Minister of Health. The Cooperative protested and several days later the ban was lifted. That same summer the milk supply was tainted by the fact that some cows had eaten weeds that affected the taste of the milk. The Cooperative also faced opposition from the major processors, Modern Dairy and Crescent Creameries, who began offering higher prices for milk, luring customers away. In 1946, the cheese operation was forced to shut its doors.²⁹⁹

St. Boniface: St. Boniface Creamery Co. opened a cheese plant here in 1932.

St. Claude: Cheese factory operating in 1920.

St. Elizabeth: Opened in 1902 and closed in 1906. Reopened from 1917-1920.

St. Eustache: Opened in 1895. Closed in 1904. Another opened in 1908, and was operated by a series of different people into 1920s.

St. Francois Xavier: Functioning in 1920

St. George: Operated from 1924-1931

St. Genevieve: Operated from 1907-1923 by A.W. Dumaine. In 1916, the owner reported that he had made 41,620 pounds (18,918 kg) of cheese in that season (May-October) from the 412,821 pounds (187,646 kg) of milk delivered to his factory, from 186 cows in the district which supplied the milk. In 1923, Dumaine moved to Winnipeg and the farmers began to ship their dairy products to St. Boniface.

St. Jean Baptiste: Opened in 1880s by D. Pelletier. Closed in 1897

St. Joseph: Operating from 1910-1912 and reopened in 1914. Closed in 1920 Another operated from 1918-1944

St. Laurent: Opened in 1883 by Mr. Lacoursiere. Still functioning in 1911 Reopened 1939

St. Leon: Opened in 1888 by Ed Labossiere

St. Malo: Opened in 1938. One operating in 1911 and 1920 as well

St. Norbert: Opened in 1880s by S.M. Barre. Closed in 1902. The Trappist Monks opened another cheese plant in 1906. Closed in the 1960s when the Trappists moved to Holland, Manitoba where they still make cheese.

St. Pierre Jolys: Several cheese factories operated in the districts around St. Pierre, beginning as early as 1895. In the 1930s there were two plants in operation in St. Pierre. One of these was affiliated with the plants in New Bothwell and Steinbach.

Ste. Rose du Lac: Opened in 1898 and closed in 1908 Reopened in 1939, operated by C. Calvi

Shoal Lake: Opened in May 1886 by G.W. Waldock. Another operating from 1925-1929

Silver Plains: (Union Point) Opened in 1895 and closed in 1897

Somerset: Thomas Trottier opened a cheese factory here in 1894. It closed in 1906, with the building and its contents being auctioned in 1907.

Starbuck: Opened in 1895 on 33-8-2E, and closed in 1900. M. Dechene, the cheese-maker, had a daily output of 200 pounds (91 kg) of cheese in 1895.

Steinbach: Established in 1889 by Mr. Reimer. Still operating in 1920. New one opened in 1936. Sold to Kraft in 1946

Stonewall: Opened in 1882 as Rockwood Cheese Factory. Building erected by S.J. Jackson

Strathclair: Opened in 1895 and closed in 1899

Stuartburn: Opened in May 1898. Closed in 1912 and reopened in 1918

Swan Lake: Charles Burrows operated a cheese factory on his farm on 25-5-11, beginning in 1890. He had a scheme to rent cows from farmers during the summer months, to hire a man to milk them and to bring the milk to the cheese factory. If he was short of milk he purchased extra from the neighbouring farmers.

Toutes Aides: Operating in this district from 1922-27

Viriden: Opened by Thomas Tapp and R. McDowell in 1887. Tapp, an experienced cheese-maker from Ontario, and his partner prepared an excellent quality cheese and were able to market it as far away as the Pacific coast. Their production for 1887 was 50 tons (45,454 kg).³⁰⁰ In 1889 Tapp bought out McDowell's interests and continued to operate the cheese factory well past the 1st World War. In 1907, he moved the factory from Viriden to his farm on SW2311-26W.

Wakopa: Opened in 1885

Westbourne: Opened by James Bray in 1888

Winkler: Rheinland cheese factory opened in 1937. In the 1960s Manco opened a cheese plant here.

Winnipeg: Piggly Wiggly opened a factory in 1932. Perhaps T. Eaton Co. purchased this plant. That company had a plant that it sold to Canada Packers in 1940.

Woodlands: Company organized with \$1200 capital, raised by selling shares for \$120 each to 35 farmers. Milk was collected daily and farmers received 65 cents for 100 pounds (45 kg) of milk. Cheese was made from June to September in blocks of 14 to 60 pounds (6-27 kg), and sold for 10 cents per pound (22 cents /kg). The plant was located on SW3-14-2W and was closed in 1894. Later the local milk was shipped to Portage la Prairie.

Woodridge: A Kraft plant was operating here in 1946.

BIBLIOGRAPHY

PRIMARY SOURCES

Dairy Farmers of Canada 1975-1987, P5192-5193, PAM
 Dairy Herd Improvement Association, P5195, PAM
 Dairy Manufacturers Association of Manitoba 1917-1965, RG1 E3, PAM
 Lowe, Freeman Henry Hetherington, MG8 B31.1, PAM
 Manitoba Dairy Association 1885-1964, MG10 E26, Boxes 5 & 6, PAM
 Manitoba Milk Producers Co-op Inc., P5185-5218, PAM
 Milk Control Board of Manitoba, RG1 L1, PAM
 Milk Prices Review Commission Records 1937-1982, AG0235:GR1672, PAM
 Winkler Papers, MG14B45, PAM

SECONDARY SOURCES

Abel, Kerry, "Morton-Boissevain Planning District Heritage Report", Unpublished Report, Historic Resources Branch, 1984

Adams, Chris, "Crumpled Globalization and Policy Innovation in Canadian Grain Politics: The Wartime Economy in the 1940s", *The Innovation Journal*, September 2001

Anderson, R.D., Working Paper No. 25, "Government Regulation of the Canadian Dairy Processing, Distributing, and Retailing Sector", 1981

Argyle History Book Committee, *Hands across the Meridian: A History of Brant-Argyle*, 2000

Arnaud Historical Committee, *Arnaud through the Years*, 1974

Ashern Historical Society, *Taming the Wilderness: A History of Ashern and District*, 1976

Baragar, Mrs. F.D., *Ripples from the Creek*, 1969

Barr, George H., "Care of Cream for Butter making", Bulletin No. 32, February 1912, Dairy and Cold Storage Series, Department of Agriculture, Dairy and Cold Storage, Commissioner's Branch

Barr, George H. and Bouchard, J.G., "Cheese Factory and Creamery Plans", Ottawa, 1914

Barre, S.M., "The 20th Century Creamery: How Centralization and Pasteurization will Solve Creamery Problems", Department of Agriculture, 1903

Barre, S.M., "Cream Raising by the Centrifugal and Other Systems", 1885

Beatty Bros, *How to Build a Dairy Barn*, 1912

Belmont History Committee, *The Path of the Pioneers: Belmont and District, 1889-1989*, 1989

Blanchard Centennial History Committee, *History of Blanchard Municipality, Volume II: 1884-1970*, 1970

- Blom, Rose R., *Tache Rural Municipality 1880-1980*, RM of Tache, 1980
- Brown, Frank, *A History of Winkler 1892-1973*, 1973
- Consultative Document Task Force on National Dairy Policy, "Growing Together", Consultative Document, July 10, 1990
- Canada Department of Trade and Commerce, Dominion Bureau of Statistics, Census of Industry, "Statistics of Dairy Factories, 1946", Ottawa, 1948
- Canada Task Force on National Dairy Policy, Report
- Canadian Dairy and Ice Cream Journal*, 1960-1969
- Canadian Dairy Information Centre, Website, March 2002
- Carberry Agricultural Society, *The Carberry Plains, 75 Years of Progress*, nd
- Carberry History Committee, *Carberry Plains: Century One 1882-1982*, 1982
- Cardale Reunion Book Committee, *Footprints and Chalk Dust*, nd
- Centennial Committee, RM of Louise, *Louise and Her Farmers*, 1979
- Chater History Book Committee, *Memoirs of an Era: Chater 1881-1981*, nd
- Clanwilliam, Rural Municipality of, *Forest to Field: A History of Clanwilliam and the Village of Erickson*, nd
- Coates, Ken and McGuiness, Fred, *Pride of the Land: An Affectionate History of Brandon's Agricultural Exhibitions*, 1985
- Collier, Anne, *Portage la Prairie*, City of Portage la Prairie, nd
- Comite culturel de Sainte-Genevieve, *Sainte-Genevieve 1900-1999*, 1999
- Cornwallis Centennial Committee, *Municipal Memories, Municipality of Cornwallis 1884-1984*, 1984
- Cypress River History Book Committee, *Pioneers, Perseverance and Progress: Cypress River 1885-1985*, 1985
- Czuboka, Michael, ed., *They Stopped at a Good Place: A History of the Beausejour, Brokenhead, Garson and Tyndall Areas of Manitoba 1875-1981*, Beausejour-Brokenhead Historical Committee, 1982
- Dauphin Historical Society, *Dauphin Valley Spans the Years*, 1970
- Davis, R., *Modern Dairy Cattle Management*, 1962

- Dominion Department of Agriculture, Branch of the Dairy and Cold Storage Commission, *Bulletins Nos. 54, 31, 39, List of Cheese Factories, Creameries, Skimming Stations*, 1911, 1913, 1917-1920, Ottawa
- Douglas History Book Club, *Echoes of a Century: Douglas 1882-1982*, 1982
- Dugald Women's Institute, *Springfield: First Rural Municipality in Manitoba 1873-1973*, 1974
- Dyck, Betty, *Hugging the Meridian: Macdonald: A Manitoba Municipal History, 1881-1981*, 1981
- Ellis, Professor J.B., *The Ministry of Agriculture in Manitoba 1870-1970*, Manitoba Department of Agriculture, 1971
- Elton Historical Committee, *Homesteaders and Homemakers: A History of Elton Municipality in its First Century*, 1973
- Empire Cream Separator Company, "Empire Milking Machines", Montreal, 1918
- Ens, Gerhard John, *Volost and Municipality: The Rural Municipality of Rhineland, 1884-1984*, 1984
- Ensminger, M.E., *The Stockman's Handbook*, 7th Ed., 1992
- Ensminger, M.E., *Dairy Cattle Science*, 1971
- Farmer, Mervin E., ed., *Stonewall, Turning a Century*, 1978
- Forrest Special Projects Group, *Family Trees & Rural Roots: A History of Forrest & District*, 2001
- Geysir Historical Society, *Faith and Fortitude: A History of the Geysir District 1880s-1980s*, 1983
- Glenella History Committee, *Tracks of time: Glenella and Districts*, 1990
- Gibson, L.G., *Fifty Years of Dairying in Manitoba*, 1935
- Gibson, L.A., "Finding the Dollar in the Cream Can", Circular 40, April 1917, Manitoba Department of Agriculture, Dairy Branch
- Gnadenenthal History Book Committee, *Gnadenenthal*, 1982
- Grieg, A.R., "Plans and Specifications for a Practical Farm Barn", Government of Saskatchewan, Department of Agriculture, 1917
- Grosse Isle Women's Institute, *The Grosse Isle Story*, 1976
- Grosse Isle Women's Institute, *The Grosse Isle Story Continues*, 2000
- Hanover, RM of, *Hanover: One Hundred Years*, 1982
- Hanover Steinbach Historical Society, *Historical Sketches of the East Reserve 1874-1910*, 1994

- Ile des Chenes et Grande Pointe History Committee: *A l'Ombre des Chenes: Souvenirs historiques d'Ile des-Chenes et Grande Pointe*, 1980
- Interlake Pioneers and Seniors of Steeprock, *Hardship and Happiness*, 1974
- John S. Pearce and Co., "Cream Separators", nd
- Jolys, J.M. and J.H. Cote, *Pages de Souvenir et d'Histoire*, nd
- Killarney Committee: *Reflections: Turtle Mountain Municipality and Killarney, 1882-1982*, 1982
- Killick, C.H.P., *Manitoba Dairying, a Century of Progress*, 1979
- La Broquerie History Book Committee, *La Paroisse St-Joachim de La Broquerie 1883-1983*, 1983
- Lake Francis History Book Committee, *Along the Mission Trail: Lake Francis, Bonnie Doon, Graysfield, Glennie*, 1988
- Langrell, Opal, *Yesteryears: Woodlands Municipal Memories*, 1978
- Langruth Historical Society, *Along the Crocus Trail*, 1984
- La Salle History Book Committee, *Then and Now: The History of La Salle, Manitoba*, 1986
- Li, Ming-fang, "The Keeping Quality of Pasteurized Milk", Thesis, University of Manitoba, 1957
- Loewen, Royden, *Blumenort: A Mennonite Community in Transition*, Blumenort Mennonite Historical Society, 1982
- Lundar Historical Society, *Wagons to Wings: History of Lundar and Districts 1872-1980*, 1980
- MacEwan, K. Eleanor, "Honourable Walter Clifford of Austin, Manitoba", Unpublished Report, Historic Resources Branch, Manitoba Culture, Heritage and Recreation, 1981
- Manitoba Department of Agriculture, *One Hundred Years of Agriculture in Manitoba*, 1980
- Manitoba Milk Producers Marketing Board, *First Annual Report*, 1975
- Manitou Centennial Book Committee, *In Rhythm with Our Roots: A History of Manitou and Area*, 1997
- Marquette and District Historical Guild, *Footsteps through the Years: Ossawa, Reaburn, Marquette, Meadow Lea, Poplar Heights*, nd
- McCormick, Veronica, *A Hundred Years in the Dairy Industry*, 1968
- McNaughton, C.H., *A Profile of the Manitoba Dairy Industry*, 1989
- McPherson, Murray, *The Brandon Hills Story*, 1979

- Melita-Arthur History Committee, *Our First Century: Town of Melita and Municipality of Arthur*, 1983
- Mills, Edward R.R., *The Story of Stony Mountain and District*, 1960
- Miniota Women's Institute, *Bridging the Years, 1879-1967*, 1967
- Minnedosa Centennial Committee, *Minnedosa Valley News*, 1982
- Mitchell, J.W., "Care of Milk and Cream", Bulletin 3, April 1911, Manitoba Agricultural College
- Mochoruk, Jim, *The People's Co-op: The Life and Times of the North End Institution*, 2000
- Montcalm, Municipalite rurale de, *Moissonneurs de la Rouge*, 1982
- Morden Centennial Committee, *Morden, Mort Cheval, Pinancewaywinning, Lake Agassiz*, 1981
- Morris History Book Committee, *Furrows in the Valley*, 1980
- Neepawa History Book Committee, *Heritage Neepawa Land of Plenty 1883-1983*, 1983
- Newdale Historical Society, *Newdale 1870-1970*, 1970
- Newdale Community Historical Society, *Newdale 2000*, 2000
- Nicholson, Karen, "A Review of the Heritage Resources of Russell-Binscarth Planning District", Unpublished Report, Historic Resources Branch, 1987
- Nicholson, Karen, "A Review of the Heritage Resources of the Virden-Wallace Planning District", Unpublished Report, Historic Resources Branch, 1986
- Nicholson, Karen, "A Review of the Heritage Resources of the Del-Win Planning District", Unpublished Report, Historic Resources Branch, 1988
- Nicholson, Karen, "A Review of the Heritage Resources of the Roblin Planning District", Unpublished Report, Historic Resources Branch, 1985
- Nicholson, Karen, "A Review of the Heritage Resources of Boyne Planning District", Unpublished Report, Historic Resources Branch, 1984
- North Norfolk-MacGregor Archives Inc., *Through Fields and Dreams: A History of North Norfolk and MacGregor*, 1998
- Oak Bluff Women's Institute, *Oak Leaves: A History of Oak Bluff District*, 1984
- Oak Lake History Book Committee, *Ox Trails to Blacktop*, 1982
- Ochre River Women's Institute, *Between Mountain and Lake 1885-1970, A History of Ochre River Municipality*, 1970
- Parkinson, Hazel McDonald, *The Mere Living: A Biography of the Hartney District*, 1957

- Penner, Lydia, *One Hundred Years, RM of Hanover*, RM of Hanover, 1982
- Petkau, Irene Friesen and Peter A., *Blumenfeld: Where Land and People Meet*, Blumenfeld Historical Committee, 1981
- Phillips, G.G., *The Rise and Fall of a Prairie Town: A History of Lauder Manitoba and Surrounding District*, 1973
- Piney Historical Committee, *Pine Valley Echoes: A History of Piney, Badger and Menisino*, nd
- Pipestone History Project, *Trails Along the Pipestone*, 1981
- Proctor, Madeline, *Woodland Echoes*, 1960
- Rapid City and District Historical Society, *Our Past for the Future: Rapid City and District*, 1978
- Rathwell Historical Committee, *Twixt Hill and Vale: A Story of Rathwell and Surrounding District*, 1970
- Rosburn History Club, *On the Sunny Slopes of the Riding Mountains: A History of Rosburn and District*, 1984
- Rosser Centennial History Book Committee, *The First Hundred Years 1893-1993, RM of Rosser*, 1993
- Ruddick, J.A., "Milk for Creameries", Dominion of Canada, Department of Agriculture Commissioner's Branch, 1902
- Sanford Women's Institute, *The Pioneer History of Sanford District*, nd
- Sanderson, Reg and William, *The Souris Story*, 1967
- Somerset History Book Committee, *Reflections - Reflects: Somerset*, 2000
- Ste. Anne Comite historique du Centenaire, *Histoire de la Paroisse Sainte-Anne Des Chenes 1876-1976*, 1976
- St. Clements Historical Committee, *The East Side of the Red*, 1984
- St. Andrews, RM of, *Beyond the Gates of Lower Fort Garry*, 1981
- Swan River Valley History Book Committee, *80 Years in the Swan River Valley*, 1978
- Swan Valley Historical Society, *Lasting Impressions, Historical Sketches of the Swan River Valley*, 1984
- Synder, Roy G., *Fifty Years of Artificial Insemination 1934-1984*, nd
- The Pas Historical Society, *The Pas: The Gateway to Northern Manitoba*, 1983
- Taylor and Field, *Scientific Farm Animal Production*, 6th Edition

Tosh, J., "Relationships among Estimated Breeding Values for Pre-weaning Calf Growth, Dam Milk Production, Cow-Calf Behaviour and Calf Performance", Thesis, University of Manitoba, 1987

Tully, D.J., "Simulation of Dairy Operations for Use as a Decision-Making Aid for the Dairy Operator", Thesis, University of Manitoba, 1981

University of Manitoba, Proceedings of the 2nd Canada-US Agricultural and Food Policy Systems Information Workshop, "Understanding Canada/US Dairy Disputes", 1996

Weir, Thomas R., ed., *Atlas of Manitoba*, Survey and Mapping Branch, 1960

Westbourne-Longbourne History, *When the West Was Bourne*, 1985

West St. Paul History Book Committee, *The Changing Scene: A History of West St. Paul*, 1989

Whitehead, RM of, *Whitehead Wanderings 1883-1983*, 1983

Whitemouth Municipal Museum Society, *Trails to Rails to Highways, A History of the Rural Municipality of Whitemouth*, 1979

Wilson, Keith, *The Belgians of Manitoba*, 1976

Zacharias, Peter, *Reinland: An Experience in Community*, Reinland Centennial Committee, 1976

----- "The Milking Machine: A Partial Solution of the Labour Problem", 1918

ENDNOTES

-
- ¹Statistics Canada, 1971 Census of Agriculture, Agricultural Data Directory, p.98
- ²Dairy Commissioner's List, Department of Agriculture, June 15, 2001
- ³Task Force on National Dairy Policy, "Growing Together", July 10, 1990, p.1
- ⁴M.E. Ensminger, *Dairy Cattle Science*, 1971
- ⁵Grant MacEwan, *Cornerstone Colony*, 1977, pp.180-188
- ⁶*Ibid.*, p.188
- ⁷*Ibid.*, pp.187-189
- ⁸Alexander Ross, as cited in C.H.P. Killick, *Manitoba Dairying, A Century of Progress*, 1979, p.14
- ⁹C.H.P. Killick, *Fifty Years of Dairying in Manitoba*, 1979, p.14
- ¹⁰*Ibid.*, p.14
- ¹¹M.E. Ensminger, Op cit
- ¹²*Ibid.*
- ¹³*Ibid.*, p.14; C.H.P. Killick, Op cit, p.56
- ¹⁴M.E. Ensminger, Op cit, p.14; C.H.P. Killick, Op cit, p.52
- ¹⁵C.H.P. Killick, Op cit, p.58
- ¹⁶*Ibid.*
- ¹⁷Veronica McCormick, *One Hundred Years in the Dairy Industry*, 1967, p.53
- ¹⁸Proceedings of the 2nd Canada/US Agricultural and Food Policy Systems Information Workshop, *Understanding Canada/United States Dairy Disputes*, University of Manitoba, 1996
- ¹⁹C.H. McNaughton, *A Profile of Manitoba Dairy Industry*, September 1989
- ²⁰C.H.P. Killick, Op cit, p.162
- ²¹*Ibid.*
- ²²*Ibid.*, p.163
- ²³Department of Agriculture, 1975 Annual Report
- ²⁴Royden Loewen, *Blumenort: A Mennonite Community in Transition*, 1982, p.103
- ²⁵C.H.P. Killick, Op cit, p.15
- ²⁶*Ibid.*, p.170
- ²⁷P.B. Justin, "Golden Opportunities for Manitoba Dairymen," *The Dominion*, Volume12
- ²⁸C.H.P. Killick, Op cit
- ²⁹*Ibid.*, p.16-17
- ³⁰*Ibid.*, p.17
- ³¹*Ibid.*, p.34
- ³²*Ibid.*, p.44
- ³³*Ibid.*, p.34
- ³⁴*Ibid.*
- ³⁵*Food in Canada*, January 1968
- ³⁶Lydia Penner, *Hanover: One Hundred Years*, p.69
- ³⁷C.H.P. Killick, *Manitoba Dairying, a Century of Progress*, 1979, pp.60-61
- ³⁸Forest Special Projects Group, *Family Trees & Rural Roots, A History of Forrest*, 2001, p.234
- ³⁹Roy G. Synder, *Fifty Years of Artificial Insemination in Canada, 1934-1984*, pp.185-86, Material from Raymond Philippot, St. Claude Museum
- ⁴⁰*Ibid.*, pp.187-88
- ⁴¹*Ibid.*
- ⁴²Material from Raymond Philippot of the St. Claude Museum
- ⁴³Mrs. F.D. Baragar, *Ripples from the Creek*, 1969, p.78
- ⁴⁴C.H.P. Killick, Op cit, p.111
- ⁴⁵*Ibid.*, p.112
- ⁴⁶*Ibid.*, p.117
- ⁴⁷*Ibid.*, p.118
- ⁴⁸Jim Mochoruk, *The People's Co-op: The Life and Times of the North End Institution*, 2000, p.134
- ⁴⁹C.H.P. Killick, Op cit, p.119
- ⁵⁰*Ibid.*, p.67

-
- ⁵¹Ibid., p.66
- ⁵²Ibid., p.67
- ⁵³Ibid.
- ⁵⁴Ibid., pp.68-9
- ⁵⁵Lundar Historical Society, *Wagons to Wings: History of Lundar and Districts 1892-1980*, 1980, p.234
- ⁵⁶C.H.P. Killick, Op cit,p.68
- ⁵⁷Rural Municipality of Clanwilliam, *Forest to Field, A History of Rural Municipality of Clanwilliam and the Village of Erickson*, p.48
- ⁵⁸Rathwell History Committee, *Twixt Hill and Dale: A History of Rathwell and Surrounding District*, 1970, p.345
- ⁵⁹Ibid.
- ⁶⁰Mrs. F.D. Baragar, Op cit, p.144
- ⁶¹Ibid.
- ⁶²C.H.P. Killick, Op cit, p.113
- ⁶³Jim Mochoruk, Op cit, p.30
- ⁶⁴Ibid., p.29
- ⁶⁵Ibid.
- ⁶⁶Ibid., p.31
- ⁶⁷Ibid.
- ⁶⁸Ibid., p.44
- ⁶⁹C.H.P. Killick, Op cit, p.113
- ⁷⁰Jim Mochoruk, Op cit, p.48
- ⁷¹Sylvia Kicenko, quoted in Jim Mochoruk, Op cit, p.95
- ⁷²Ibid.
- ⁷³Ibid., p.96
- ⁷⁴C.H.P. Killick, Op cit, p.115
- ⁷⁵Mochoruk, Op cit, p.96
- ⁷⁶Ibid., p.118
- ⁷⁷Ibid., p.162
- ⁷⁸C.H.P. Killick, Op cit, p.11
- ⁷⁹*Canadian Dairy and Ice Cream Journal*, March, 1966, p.47
- ⁸⁰Argyle History Book Committee, *Hands across the Meridian: A History of Brant-Argyle*, p.26
- ⁸¹Ibid., p.228
- ⁸²*Food in Canada*, January 1968, Copy of an article supplied by St. Claude Museum
- ⁸³C.H.P. Killick, Op cit, p.34
- ⁸⁴Ibid., p.34
- ⁸⁵*Modern Dairy*, July 1969, pp.31-32
- ⁸⁶Opal Langrell, *Yesteryears: Woodlands Municipal Memories*, p.217
- ⁸⁷*Modern Dairy*, July/August 1975, p.26
- ⁸⁸Ibid.
- ⁸⁹Robert D. Anderson, *Working Paper No. 25: Government Regulation of the Canadian Dairy Processing, Distributing and Retailing Sector*, Toronto, 1981, p.8
- ⁹⁰M.E. Ensminger, *The Stockman's Handbook*, 7th, pp.277-280
- ⁹¹C.H.P. Killick, Op cit, p.116
- ⁹²Tully, D.J., "Simulation of Dairy Operations for Use as a Decision-Making Aid for the Dairy Operator", Thesis, University of Manitoba, 1981, p.10
- ⁹³Manitoba Agriculture, List of Active Dairies, 2001-06-15
- ⁹⁴Cypress River History Book Committee, *Pioneers and Perseverance: Cypress River 1885-1985*, pp.487-91
- ⁹⁵Ibid., p.286; Material from Raymond Philippot, St. Claude Museum, October, 2002
- ⁹⁶Ibid., p.283
- ⁹⁷Rathwell Historical Committee, *Twixt Hill and Vale: A Story of Rathwell and Surrounding District*, pp.119-20
- ⁹⁸Ibid., p.269
- ⁹⁹Somerset History Book Committee, *Reflections - Reflect: Somerset*, p.94

-
- ¹⁰⁰ Gerhard John Ens, *Volost and Municipality: The Rural Municipality of Rhineland, 1884-1984*, p.155
- ¹⁰¹ Irene and Peter Petkau, *Blumenfeld, Where Land and People Meet*, p. 53
- ¹⁰² Zacharias, Peter, *Reinland: An Experience in Community*, p.171
- ¹⁰³ Gnadenthal History Book Committee, *Gnadenthal*, p.171
- ¹⁰⁴ Oak Bluff Women's Institute, *Oak leaves, A History of Oak Bluff*, p.38
- ¹⁰⁵ *Ibid.*, p.401
- ¹⁰⁶ *Ibid.*, p.364
- ¹⁰⁷ LaSalle History Book Committee, *Then and Now: The History of La Salle, Manitoba*, p.92
- ¹⁰⁸ *Ibid.*, p.222
- ¹⁰⁹ Morris History Book Committee, *Furrows in the Valley*, p.237
- ¹¹⁰ *Food in Canada*, January 1968, Material from St. Claude Museum
- ¹¹¹ Mrs. F.D. Baragar, *Ripples from the Creek*, p.32
- ¹¹² *Ibid.*
- ¹¹³ Manitoba Agriculture Active Dairy List, 2001-06-15
- ¹¹⁴ The North Norfolk-MacGregor Archives Inc., *Through Fields and Dreams: A History of North Norfolk and MacGregor*, 1998, p.646
- ¹¹⁵ La Municipalite rurale de Montcalm, *Moissonneurs de la Rouge*, pp.310, 210
- ¹¹⁶ Manitoba Agriculture Active Dairy List, 2001-06-15
- ¹¹⁷ Morden Centennial Committee, *Morden, Mort Cheval, Pinancewaywinning, Lake Agassiz*, p.352
- ¹¹⁸ Westbourne-Longbourne History, *When the West Was Bourne*, p.101
- ¹¹⁹ St. Clements Historical Committee, *The East Side of the River*, pp.297-309
- ¹²⁰ *Ibid.*, p.310
- ¹²¹ RM of St. Andrews, *Beyond the Gates of Lower Fort Garry*, pp.408, 450
- ¹²² *Ibid.*, pp.198-99
- ¹²³ *Ibid.*, p.331
- ¹²⁴ *Ibid.*, p.336
- ¹²⁵ *Ibid.*, pp.390-91
- ¹²⁶ Gross Isle Women's Institute, *Gross Isle Story*, pp.339, 281; Grosse Isle Women's Institute, *The Gross Isle Story Continued*, p.142
- ¹²⁷ Edward R.R. Mills, *The Story of Stony Mountain and District*, p.83
- ¹²⁸ Argyle History Book Committee, *Hands across the Meridian: A History of Brant-Argyle*, pp.362, 36
- ¹²⁹ *Ibid.*, pp.33-34
- ¹³⁰ Ledohowski, Edward, *The Poplarfield & District Millennium Album*, p.119
- ¹³¹ Geysir Historical Society, *Faith and Fortitude, A History of the Geysir District 1880's - 1980's*, p.231
- ¹³² Lake Francis History Book Committee, *Along the Mission Trail: Lake Francis, Bonnie Doon, Grayfield, Glennie*, p.206
- ¹³³ *Ibid.*, p.276
- ¹³⁴ *Ibid.*, p.288
- ¹³⁵ *Ibid.*, pp.362-3
- ¹³⁶ *Ibid.*, pp.9, 426
- ¹³⁷ *Ibid.*, pp.431-2
- ¹³⁸ Opral Langrell, *Yesteryears: Woodlands Municipal Memories*, p.184
- ¹³⁹ Madeline Proctor, *Woodlands Echoes*, p.104
- ¹⁴⁰ Opral Langrell, *Op cit*, p.151
- ¹⁴¹ Marquette and District Historical Guild, *Footsteps through the Years: Ossawa, Reaburn, Marquette, Meadow Lea, Poplar Heights*, p.80
- ¹⁴² *Ibid.*, p.83
- ¹⁴³ *Ibid.*, p.300
- ¹⁴⁴ *Ibid.*, pp.300-303, 319
- ¹⁴⁵ *Ibid.*, p.195
- ¹⁴⁶ *Ibid.*, p.199
- ¹⁴⁷ *Ibid.*, p.295
- ¹⁴⁸ Swan River Valley History Book Committee, *80 Years in the Swan River Valley*, p.253
- ¹⁴⁹ Hanover, RM of, *Hanover: One Hundred Years*, p.61
- ¹⁵⁰ *Ibid.*

-
- ¹⁵¹ Ibid., p.62
¹⁵² Ibid., p.63
¹⁵³ Ibid., p.65
¹⁵⁴ Royden Loewen, *Blumenort, A Mennonite Community in Transition*, p.375
¹⁵⁵ Comite culturel de Saint-Genevieve, *Sainte-Genevieve 1900-1999*, p.23
¹⁵⁶ Ibid., p.29
¹⁵⁷ J.M. Jolys and J.H. Cote, *Pages de Souvenirs d'Histoire*, p.252
¹⁵⁸ Ibid., p.254.
¹⁵⁹ Whitemouth Municipal Museum Society, *Trails to Rails to Highways: A History of the Rural Municipality of Whitemouth*, p.103
¹⁶⁰ Ibid., p.139
¹⁶¹ Ibid., p.187
¹⁶² Ibid., p.202
¹⁶³ Ibid., p.216
¹⁶⁴ Cardale Reunion Book Committee, *Foot Prints and Chalk Dust*, p.77
¹⁶⁵ Carberry Agricultural Society, *The Carberry Plains, 75 Years of Progress*, pp.19-20
¹⁶⁶ Carberry History Committee, *Carberry Plains, Century One, 1882-1982*, p.9
¹⁶⁷ Rural Municipality of Clanwilliam, *From Forest to Field: A History of Clanwilliam and the Village of Erickson*, pp.410, 416
¹⁶⁸ Douglas History Book Club, *Echoes of a Century, Douglas 1882-1982*, p.108
¹⁶⁹ Ibid., pp.152-3
¹⁷⁰ Ibid., p.209
¹⁷¹ Ibid., p.273
¹⁷² Ibid., p.108
¹⁷³ Cornwallis Centennial Committee, *Municipal Memories: Municipality of Cornwallis 1884-1984*, p.177
¹⁷⁴ Ibid., p.146
¹⁷⁵ Ibid., p.344
¹⁷⁶ Ibid., p.167
¹⁷⁷ Ibid., p.168; Manitoba Agriculture List of Active Dairies, 2001-06-15
¹⁷⁸ Ibid., p.249
¹⁷⁹ Ibid., p.346
¹⁸⁰ Chater History Book Committee, *Memories of an Era: Chater 1881-1981*, p. 143
¹⁸¹ Cornwallis Centennial Committee, Op cit, p.194
¹⁸² Ibid., p.168
¹⁸³ Ibid., p.183
¹⁸⁴ Ibid., p.251
¹⁸⁵ Ibid., p.200
¹⁸⁶ Ibid., p.231
¹⁸⁷ Ibid., p.237
¹⁸⁸ Elton Historical Committee, *Homesteaders and Homemakers: The History of Elton Municipality*, p.211
¹⁸⁹ Ibid., p.221
¹⁹⁰ Ibid., p.226
¹⁹¹ Ibid., p.301
¹⁹² Ibid., p.311
¹⁹³ Ibid., p.454
¹⁹⁴ Ibid., p.309
¹⁹⁵ Ibid., p.418
¹⁹⁶ RM of Whitehead, *Whitehead Wanderings 1883-1983*, p.156
¹⁹⁷ Killarney Committee, *Reflections: Turtle Mountain Municipality and Killarney*, p.46; Manitoba Agriculture Active Dairy List 2001-06-15
¹⁹⁸ C.P.H. Killick, Op cit p. 24-25
¹⁹⁹ Keith Wilson, *The Belgians in Manitoba*, p.78
²⁰⁰ Ibid., p.78
²⁰¹ St. Clements Historical Committee, Op cit, p.456
²⁰² C.H.P. Killick, Op cit, p.47

- ²⁰³ Karen Nicholson, "A Review of the Heritage Resources of Virden-Wallace Planning District", p.120
- ²⁰⁴ C.H.P. Killick, Op cit, p.136
- ²⁰⁵ Ibid.
- ²⁰⁶ Dominion Department of Agriculture, Branch of the Dairy and Cold Storage Commissioner, Ottawa Ontario, *Bulletin No. 54*, pp.72-74
- ²⁰⁷ Royden Loewen, Op cit, p.373
- ²⁰⁸ Rennet is a substance containing the enzyme rennin, prepared from the stomachs of calves. It is used for curdling milk in making cheese. Rennin coagulates milk by converting caseinogens to casein.
- ²⁰⁹ Morris History Book Committee, Op cit, p.340
- ²¹⁰ C.H.P. Killick, Op cit, p.137
- ²¹¹ *Canadian Dairy and Ice Cream Journal*, September 1965, p.19
- ²¹² Robert D. Anderson, Working Paper No. 25 Government Regulation of the Canadian Dairy Processing, Distributing and Retailing Sector, September 1981
- ²¹³ C.H.P. Killick, Op cit, p.147
- ²¹⁴ Ibid., p.138
- ²¹⁵ Ibid., p.140
- ²¹⁶ Sanford Women's Institute, *The Pioneer History of Sanford District*, p.15
- ²¹⁷ Morris History Book Committee, Op cit, p.255
- ²¹⁸ K.G. MacKay, "Butter making on the Farm", p.2
- ²¹⁹ C.H.P. Killick, Op cit, p.20
- ²²⁰ J.H. Ellis, *The Ministry of Agriculture in Manitoba, 1870-1970*, p.235
- ²²¹ S.A. Barre, "The 20th Century Creamery: How Centralization and Pasteurization Will Solve the Creamery Problem." Department of Agriculture, 1903, p.4
- ²²² Ibid. p.6
- ²²³ Interlake Pioneers and Seniors of Steeprock, *Happiness and Hardship*, p.11
- ²²⁴ Langruth Historical Society, *Along the Crocus Trail*, 1984, p.102
- ²²⁵ Lundar Historical Society, *Wagons to Wings: History of Lundar and Districts 1872-1980*, p.74
- ²²⁶ J.H. Ellis, Op cit, p.145
- ²²⁷ The Manitoba Public Service Bulletin, 1916, quoted in Rose Blum, *Tache Rural Municipality 1880-1980*, p.79
- ²²⁸ C.H.P. Killick, Op cit, p.30
- ²²⁹ Ibid., p.20
- ²³⁰ Ibid., p.25
- ²³¹ Ibid., p.32
- ²³² Winkler Papers 3120-2121, Letter from L.A. Rose, President of Manitoba Dairy Association to V. Winkler, Minister of Agriculture and Immigration, November 18, 1915
- ²³³ C.H.P. Killick, Op cit, p.35
- ²³⁴ Farm and Dairy Magazine
- ²³⁵ List of Cheese Factories, Creameries, Skimming Stations 1917-1920; C.H.P. Killick, Op cit, p.81
- ²³⁶ C.H.P. Killick, Op cit, p.32
- ²³⁷ Winkler Papers 3120-3121, Letter from George Winram to V. Winkler, Minister of Agriculture, June 25, 1919
- ²³⁸ Winkler Papers 3125
- ²³⁹ J.A. Ruddick, "Milk for Creameries", Department of Agriculture Commissioner's Branch, Dominion of Canada, 1902, p.5
- ²⁴⁰ Lowe Papers, PAM
- ²⁴¹ Farm and Dairy Magazine
- ²⁴² Department of Trade and Commerce Dominion Bureau of Statistics. Statistics of Dairy Factories, 1946, Ottawa 1948
- ²⁴³ Ibid., Statistics of Dairy Factories, 1946
- ²⁴⁴ Dairy Farmers of Canada Facts and Figures, 1985, Table 5
- ²⁴⁵ Dairy farmers of Canada, Facts and Figures, 1985, Table 30
- ²⁴⁶ Robert D. Anderson, Op cit, p.9
- ²⁴⁷ C.H.P. Killick, Op cit, p.31

- ²⁴⁸ Historic Resources Branch, *4-H Clubs in Manitoba*, p.1; A plaque and pamphlet was prepared by Manitoba Cultural Affairs and Historical Resources in 1983.
- ²⁴⁹ Ken Coates and Fred McGuiness, *Pride of the Land: An Affectionate History of Brandon's Agricultural Exhibitions*, 1985, p.47
- ²⁵⁰ *Ibid.*, p.173
- ²⁵¹ C.H.P. Killick, *Op cit*, pp.17-18
- ²⁵² Manitoba Milk Producers Co-op Inc. Collection, PAM
- ²⁵³ *The Canadian Dairy and Ice Cream Journal*, March 1959, pp.45-46
- ²⁵⁴ Argyle History Book Committee, *Op cit*, p.36
- ²⁵⁵ Beatty Bros., *How to Build a Dairy Barn*, 1912, Forward
- ²⁵⁶ Manitou Centennial Book Committee, *In Rhythm with Our Roots: A History of Manitou and Area*, p.302
- ²⁵⁷ M.E. Ensminger, *The Stockman's Handbook*, p.617
- ²⁵⁸ Ashern Historical Society, *Taming a Wilderness, A History of Ashern and District*, p.283
- ²⁵⁹ RM of Louise Centennial Committee, *Louise and Her Farmers*, p.47
- ²⁶⁰ Newdale Community Historical Society, *Newdale 2000*, pp.133-34, reprinted from *The Nor' West Farmer*, February 5, 1900, See Figure
- ²⁶¹ C.H.P. Killick, *Op cit*, p.85
- ²⁶² Holle, Peter, "Marketing Boards Cost Us a Lot", *Winnipeg Free Press*, Saturday, October 27, 2001, p.A21
- ²⁶³ Oak Bluff Women's Institute, *Oak Leaves*, p.43; C.H.P. Killick, *Op cit*, p.102
- ²⁶⁴ Interview, Randy Bossuyt, October 26, 2001
- ²⁶⁵ Cornwallis Centennial Committee, *Op cit*, p.189
- ²⁶⁶ The Pas Historical Society, *The Pas*, pp.249-252
- ²⁶⁷ Jim Mochoruk, *Op cit*, p.44
- ²⁶⁸ *Ibid.*, p.82
- ²⁶⁹ *Ibid.*, p 167
- ²⁷⁰ K. Eleanor MacEwan, "Honourable Walter Clifford of Austin, Manitoba", Historic Resources Branch, pp.1-2
- ²⁷¹ Belmont History Committee, *The Paths of the Pioneers: Belmont and District, 1889-1989*, pp.49-51
- ²⁷² C.H.P. Killick, *Op cit*, p.77
- ²⁷³ Karen Nicholson, "A Review of Heritage Resources of the Boyne Planning District", pp.58-9
- ²⁷⁴ Rural Municipality of Clanwilliam, *Op cit*, pp.52-3
- ²⁷⁵ C.H.P. Killick, *Op cit*, p.86
- ²⁷⁶ Hazel McDonald Parkinson, *The Mere Living: A Biography of the Hartney District*, p.174
- ²⁷⁷ Melita-Arthur History Committee, *Our First Century: Town of Melita and Municipality of Arthur*, p.351
- ²⁷⁸ Minnedosa Centennial Committee, *Minnedosa Valley News*, p.40; Jim Mochoruk, *Op cit*, pp.126, 135,167
- ²⁷⁹ *Modern Dairy*, 1960, p.18
- ²⁸⁰ C.H.P. Killick, *Op cit*, pp.93-95
- ²⁸¹ Neepawa History Book Committee, *Neepawa, Land of Plenty*, p.104
- ²⁸² Newdale Historical Society, *Op cit*, pp 57, 134
- ²⁸³ Jim Mochoruk, *Op cit*
- ²⁸⁴ Rossburn History Committee, *On the Sunny Slopes of the Riding Mountains: A History of Rossburn and District*, pp.168-9
- ²⁸⁵ Rapid City and District Historical Society, *Our Past for The Future: Rapid City and District*, pp.32, 56, 60
- ²⁸⁶ Pipestone History Project, *Trails along the Pipestone*, p.441
- ²⁸⁷ Rossburn History Club, *Op cit*, pp.168-170
- ²⁸⁸ Ste. Anne Comite Historique du Centenaire, *Histoire de la Paroisse de Sainte-Anne-Des-Chenes 1876-1976*, p.193
- ²⁸⁹ Material from St. Claude Museum
- ²⁹⁰ *Russell Banner*, February 7, 1918, p.1
- ²⁹¹ Reg and Wm. Sanderson, *The Souris Story*, p.98
- ²⁹² Karen Nicholson, "A Review of Heritage Resources of Virden-Wallace Planning District", pp.122-3
- ²⁹³ Karen Nicholson, "A Review of the Heritage Resources of Del-Win Planning District", pp.32-36

²⁹⁴G.G. Phillips, *The Rise and Fall of a Prairie Town: A History of Lauder Manitoba and Surrounding District*, p.14

²⁹⁵Newdale History Society, *Newdale 1870-1970*, p.57

²⁹⁶Rosburn History Club, *Op cit*, p.168

²⁹⁷*Ibid.*, p.207

²⁹⁸Ste. Anne Comite Historique du Centaire, *Op cit*, p.189

²⁹⁹*Ibid.*, pp.189-93

³⁰⁰Karen Nicholson, "A Review of the Heritage Resources of Virden-Wallace Planning District", p.120